

EMEA VERSION

# POLARIS *GENERAL*

2021

ACCESSORIES + APPAREL



# THE RIGHT GEAR ALWAYS MATTERS

## 2021 LINEUP

### GENERAL

#### DELUXE (2 & 4 SEAT)



#### GENERAL 1000 DELUXE

#### PREMIUM PLUS:

FOX PODIUM X 2.0 QS3 SHOCKS  
SPORT ROOF  
STAGE 1 AUDIO SYSTEM BY ROCKFORD FOSGATE  
CONVEX REAR VIEW MIRROR

Now Available in Two Color Packages

RIDE COMMAND + STAGE 4 AUDIO SYSTEM BY ROCKFORD FOSGATE UPGRADE AVAILABLE.

## CONTENTS

### ACCESSORIES 06

WINDSHIELDS & REAR PANELS	08
DOORS	10
ROOFS	12
VEHICLE & RIDER PROTECTION	13
STORAGE	14
CAB COMFORT	16
HUNT	18
POLARIS NORTHSTAR COOLERS	20
RIDE COMMAND & AUDIO	22
LIGHTING	24
WHEELS & TIRES	26
WINCHES	34
PLOWS & TRACKS	35

### PARTS & GARAGE 36

MAINTENANCE	36
OIL & LUBRICANTS	38
SERVICE PARTS	40
HD PARTS	42
VEHICLE CARE & TRAILERING	44

### APPAREL & HELMETS 46

OUTERWEAR & PROTECTION	46
LIFESTYLE APPAREL & CAPS	52
CAMO & GIFTS	54

## ELEVATE YOUR ADVENTURE

OFF-ROAD'S PREMIER FAMILY OF CROSSOVER SIDE-BY-SIDES. No matter which GENERAL you choose, you begin every adventure with the best performance, the greatest utility, and the most comfortable ride you can get in a side-by-side. When you customize with Polaris Engineered Accessories you have the confidence to take on any task or any trail.

**DESIGNED**



Designed by the same people who designed your vehicle.

**TESTED**



Extensively tested in the field so you ride with 100% confidence.

**TRUSTED**



65 years in the business. The #1 name in Off-Road.

**WE HOLD OUR PARTNERS TO THE SAME STANDARDS**



WHEELS, TIRES & LIGHTING DESIGNED WITH POLARIS TO MAXIMIZE PERFORMANCE  
P. 25 & 26



A GLOBAL LEADER IN AUDIO INNOVATION, DESIGN & ENGINEERING  
P. 23



PRODUCTS SO GOOD THEY REPLACE OR REPAIR THEM FOR LIFE  
P. 24



MAKING PRODUCTS FOR AVID SPORTSMEN SINCE 1943  
P. 18

# ENGINEERED TO TAKE ON **THE ELEMENTS**

## TESTED & PROVEN



DUST

WIND

**BUILD YOUR CAB SYSTEM  
STARTING ON P. 08**



### PROFILE TUBE DESIGN

Contours built into the cage deliver a premium sealing surface.



### PERFECT FIT, PERFECT SEAL

A 360° gasket seal provides our tightest-sealing cab.



### LOCK & RIDE EASY ON & OFF

Adapt to your needs and environment with exclusive tool-less, easy-on, easy-off Lock & Ride components.



### PLUG & PLAY ELECTRICAL

## **EFFORTLESSLY ADD LIGHTS, HEAT, WIPERS & AUDIO.**

A revolution in electrical accessory integration, the Polaris PULSE Electrical System allows for a simple plug & play approach for adding power to Polaris Engineered Accessories.

Look for  to identify Polaris PULSE ready accessories.



## **COMFORT YOU HAVE TO EXPERIENCE TO BELIEVE**

Our cab components create an experience enhancing interior, offering supreme comfort to your vehicle.



## ELEVATE YOUR ADVENTURE



## BLAZE A NEW TRAIL



## PREPARE FOR THE HUNT



## SPORT ESSENTIALS

**LOCK & RIDE** Vented Windshield - Hard Coat Poly: P. 08

Windshield Wiper & Washer System: P. 08

**LOCK & RIDE** Bed Extender: P. 14

Polaris Northstar 30 QT Cooler: P. 20

**LOCK & RIDE** Spare Tire Carrier: P. 14

Pro Armor 33" Combo LED Light Bar: P. 25

Light Bar Harness: P. 25

Rear Sport Bumper: P. 13

4-Seat Extreme Kick-Out Rock Sliders: P. 13

**LOCK & RIDE** Vented Windshield - Hard Coat Poly: P. 08

Sport Roof - Poly: P. 12

XL Fender Flares: P. 13 **NOT SHOWN**

**LOCK & RIDE** Cargo Box: P. 15

RIGID SR-Series Combo Light Bar: P. 25

Pro Armor Wheel & Tire Set: P. 33

29" Mud XC & 14" Shackles - Matte Black

Winch: P. 34

**LOCK & RIDE** Full Windshield - Glass: P. 08 **NOT SHOWN**

Windshield Wiper & Washer System: P. 08 **NOT SHOWN**

**LOCK & RIDE** Rear Panel - Glass: P. 09

Pro Armor 33" Combo LED Light Bar: P. 25 **NOT SHOWN**

Polaris Pulse LED Light Bar Harness: P. 16 **NOT SHOWN**

In addition to stock accessories

Premium Roof - Poly: P. 12

**LOCK & RIDE** Full Windshield - Glass: P. 08

Windshield Wiper & Washer System: P. 08

**LOCK & RIDE** Rear Panel - Glass: P. 09

Polaris Northstar 30 QT Cooler: P. 20

# WINDSHIELDS

Keep the elements out and control air flow into the cab.

POLARIS ENGINEERED ADVANTAGES

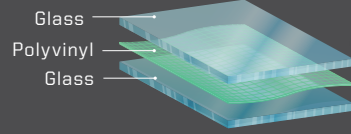

## GLASS VS POLY

- Superior optical clarity [automotive level]
- Scratch resistant
- Curved to fit, seals tight
- Cold weather / heavy duty
- Wiper ready (windshield only)

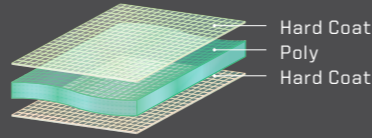

- Lightweight, flexible, easy to store/remove
- Impact-resistant
- Tight seal keeps out rain and dust
- Hard Coat: 30x more scratch resistance than regular poly windshields



**LOCK & RIDE**  
**REVOLUTIONARY INSTALLATION**



**AIRTIGHT GASKET SEAL**

### GLASS

### HARD COAT POLY

### POLY

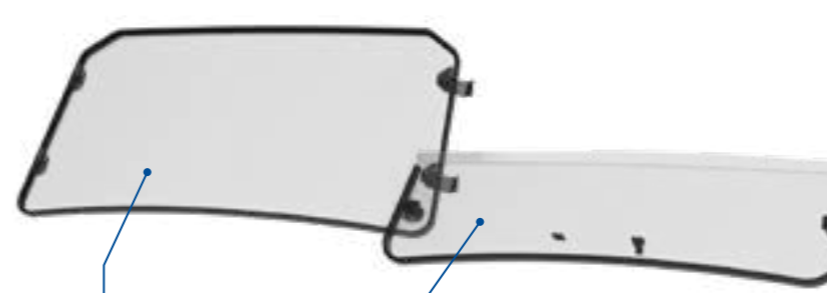
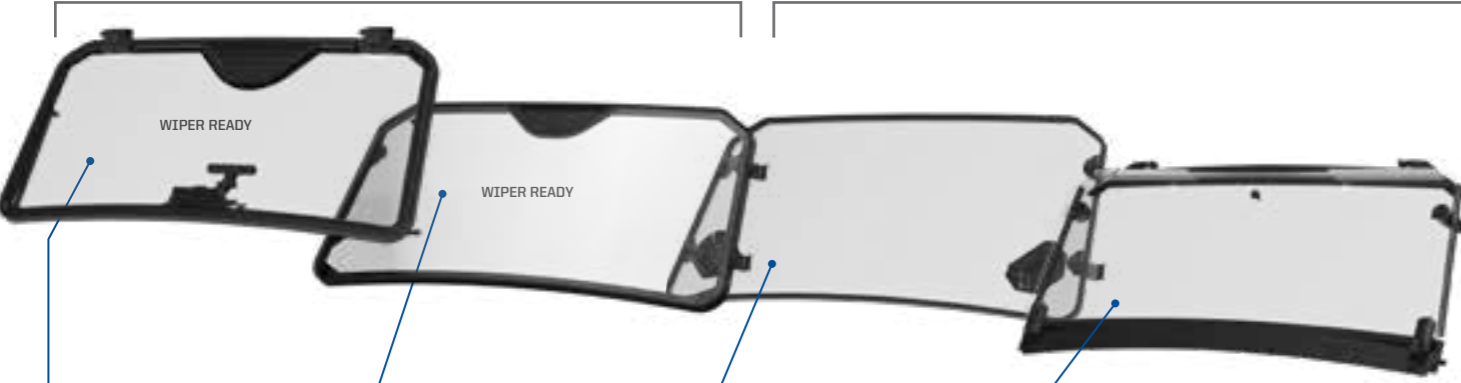

**TIP-OUT WINDSHIELD - GLASS** TOP SELLER  
» 2881108  
POLARIS GENERAL XP 1000/4 '20-21  
POLARIS GENERAL 1000/4 '16-21

**NEW**  
**LOCK & RIDE**  
**FULL WINDSHIELD - GLASS** TOP SELLER  
» 2889064  
POLARIS GENERAL XP 1000/4 '20-21  
POLARIS GENERAL 1000/4 '16-21

**LOCK & RIDE**  
**VENTED WINDSHIELD - HARD COAT POLY**  
» 2884223  
POLARIS GENERAL XP 1000/4 '20-21  
POLARIS GENERAL 1000/4 '16-21

**NEW**  
**LOCK & RIDE**  
**FLIP-DOWN WINDSHIELD - HARD COAT POLY**  
» 2889156  
POLARIS GENERAL XP 1000/4 '20-21  
POLARIS GENERAL 1000/4 '16-21

**LOCK & RIDE**  
**FULL WINDSHIELD - HARD COAT POLY**  
» 2884337  
POLARIS GENERAL XP 1000/4 '20-21  
POLARIS GENERAL 1000/4 '16-21

**LOCK & RIDE**  
**HALF WINDSHIELD - POLY**  
» 2881111  
POLARIS GENERAL XP 1000/4 '20-21  
POLARIS GENERAL 1000/4 '16-21



**WINDSHIELD WIPER & WASHER SYSTEM** TOP SELLER  
» 2881090  
POLARIS GENERAL XP 1000/4 '20-21  
POLARIS GENERAL 1000/4 '16-21



Offers fully-sealed or flipped-down venting options. Upper half detaches, leaving lower half for protection with maximum ventilation.



# REAR PANELS

Turbulent air forms above the cargo bed and behind the cab when you add a windshield. This swirl can carry dirt, dust, leaves, and rain into the cab. Eliminate this phenomenon and **control the swirl** by installing a rear panel.



**LOCK & RIDE**  
**REAR PANEL - GLASS** TOP SELLER  
» 2881113  
POLARIS GENERAL XP 1000/4 '20-21  
POLARIS GENERAL 1000/4 '16-21



**LOCK & RIDE**  
**REAR PANEL - POLY**  
» 2881112  
POLARIS GENERAL XP 1000/4 '20-21  
POLARIS GENERAL 1000/4 '16-21

**ADD A REAR PANEL TO REDUCE THE DUST SWIRL**

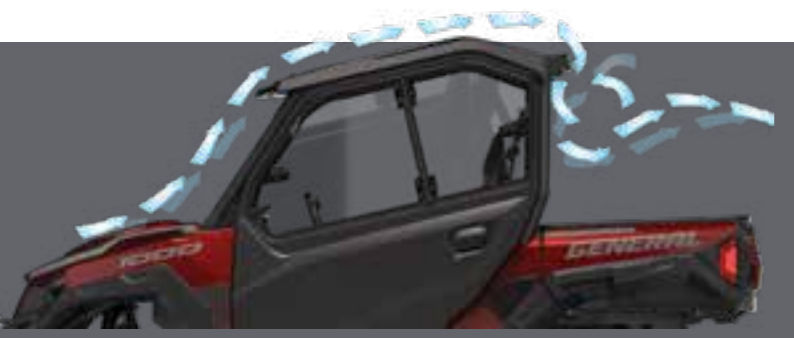

ACCESSORIES

WINDSHIELDS & REAR PANELS

DOORS

ROOFS & PROTECTION

STORAGE, CAB COMFORT & HUNT

COOLERS

RIDE COMMAND & AUDIO

LIGHTING

WHEELS & TIRES

WINCHES & PLOWS

# DOORS

**COMPLETE YOUR CAB.** POLARIS GENERAL comes equipped with half doors. To create an enclosed cab for increased protection from the elements, choose from two great Polaris options.



## REPLACE STOCK HALF DOORS

### PREMIUM POLY FULL DOORS

- Impact and scratch-resistant tempered glass
- Fully-sealed design keeps elements out for a premium in-cab environment
- Hinged window adjustability
- Soft-touch, easy-to-clean premium interior liner

#### 2-SEAT

- Six-way glass window adjustability

» 2883717  
POLARIS GENERAL XP 1000/4 '20-21  
POLARIS GENERAL 1000/4 '16-21

#### 4-SEAT

- Push-out windows
- Kit includes B-pillar cover seal

» 2883082  
POLARIS GENERAL XP 4 1000 '20-21  
POLARIS GENERAL 4 1000 '17-21

POLARIS ENGINEERED ADVANTAGES



PREMIUM INTERIOR HANDLE AND LINER



A PERFECT FIT FOR THE PERFECT SEAL



## ADD UPPER DOORS TO STOCK HALF DOORS

### ZIP WINDOW UPPER DOORS

- Durable, rugged canvas stitched over a robust steel frame
- Lightweight, UV-resistant construction
- Retention straps for increased strength
- Zipper windows for increased venting options
- Mounts easily by drilling into stock doors (drill hole plugs included)

#### 2-SEAT

» 2882548  
POLARIS GENERAL XP 1000 '20-21  
POLARIS GENERAL 1000 '18-21

NOT SHOWN

#### 4-SEAT

» 2883453  
POLARIS GENERAL XP 4 1000 '20-21  
POLARIS GENERAL 4 1000 '18-21

# ROOFS

Protect yourself from the elements. The right roof shields you from the sun and driving rain.

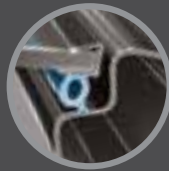

**A PERFECT FIT FOR THE PERFECT SEAL**

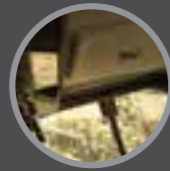

**PREMIUM FEATURES & QUIETER RIDE**



**KEEP MOISTURE MOVING**

**POLARIS ENGINEERED ADVANTAGES**

## ALUMINUM VS POLY

- High protection strength
- Lower profile
- Sleek style
- Water run-off
- Pre-existing mounting features
- Liner ready
- Lightweight

### 2-SEAT

#### ROOF - ALUMINUM

- » 2881105  
POLARIS GENERAL XP 1000 '20-21  
POLARIS GENERAL 1000 '16-21



#### PREMIUM ROOF - POLY

- » 2883800  
POLARIS GENERAL XP 1000 '20-21  
POLARIS GENERAL 1000 '16-21



**INCLUDES PREMIUM ROOF LINER**

#### SPORT ROOF - POLY

- » 2883780  
POLARIS GENERAL XP 1000 '20-21  
POLARIS GENERAL 1000 '16-21



### 4-SEAT

#### PREMIUM ROOF - POLY

- » 2883801  
POLARIS GENERAL XP 4 1000 '20-21  
POLARIS GENERAL 4 1000 '17-21



**INCLUDES PREMIUM ROOF LINER**

#### TOP SELLER SPORT ROOF - POLY

- » 2883781  
POLARIS GENERAL XP 4 1000 '20-21  
POLARIS GENERAL 4 1000 '17-21

#### POLY ROOF LINER

- » 2883802  
POLARIS GENERAL XP 4 1000 '20-21  
POLARIS GENERAL 4 1000 '17-21  
Compatible with Sport Roof - Poly (2883781), sold separately



# VEHICLE & RIDER PROTECTION

Arm your POLARIS GENERAL with Polaris Engineered bumpers and guards to take on any challenge. Engineered for easy, secure installation; providing added protection for lights, bodywork and suspension.



#### REAR BUMPERS NOT SHOWN

##### SPORT

- » 2884345  
POLARIS GENERAL XP 1000/4 '20-21  
POLARIS GENERAL 1000/4 '16-21

#### HMW A-ARM GUARDS NOT SHOWN

##### FRONT

- » 2880274  
POLARIS GENERAL XP 1000/4 '20-21  
POLARIS GENERAL 1000/4 '16-21

##### REAR

- » 2880171  
POLARIS GENERAL 1000 '16-21

#### FENDER FLARES

##### XL TOP SELLER

- » 2884220  
POLARIS GENERAL 1000/4 '16-21  
Not compatible with Low Profile Rock Sliders  
Standard on GENERAL XP models

#### HIGH CLEARANCE A-ARM GUARDS

##### FRONT

- » 2884221  
POLARIS GENERAL XP 1000/4 '20-21

##### REAR

- » 2884222  
POLARIS GENERAL XP 1000/4 '20-21

#### FRONT BUMPERS

##### A SPORT LOW PROFILE

- » 2881094  
POLARIS GENERAL XP 1000/4 '20-21  
POLARIS GENERAL 1000/4 '16-21

##### B SPORT UPPER

- » 2881525  
POLARIS GENERAL XP 1000/4 '20-21  
POLARIS GENERAL 1000/4 '16-21  
Requires Sport Low Profile Front Bumper

#### ROCK SLIDERS NOT SHOWN

##### LOW PROFILE

- » 2881102  
POLARIS GENERAL 1000 '16-21  
Not compatible with XL Fender Flares

##### EXTREME KICK-OUT

- » 2-SEAT • 2881101  
POLARIS GENERAL XP 1000 '20-21  
POLARIS GENERAL 1000 '16-21
- » 4-SEAT • 2881992  
POLARIS GENERAL XP 4 1000 '20-21  
POLARIS GENERAL 4 1000 '17-21

#### EXPANSION ANCHOR MOUNTS

TOUGH EXPANSION ANCHOR MOUNTS DESIGNED FOR POLARIS GENERAL ALLOW FOR QUICK INSTALL OF ROCK SLIDERS AND BUMPERS WITHOUT DAMAGING THE VEHICLE'S FRAME.





# STORAGE

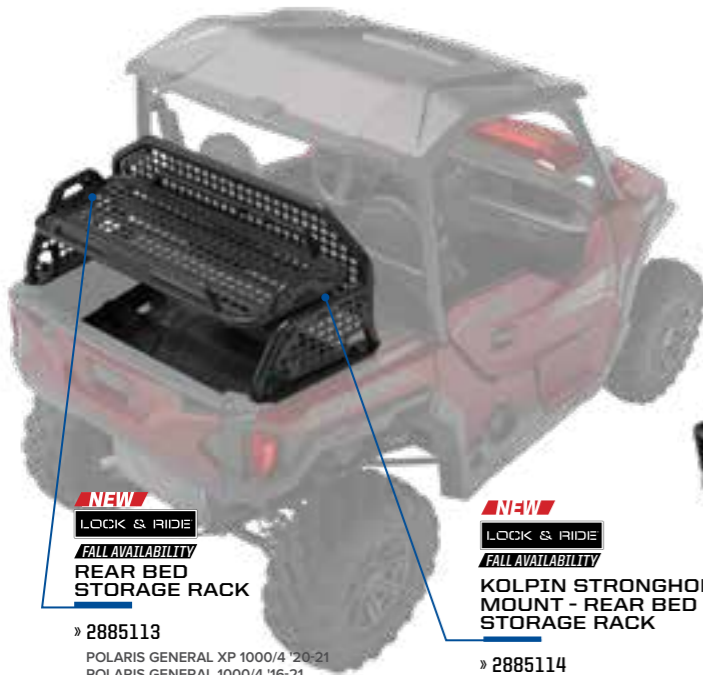

**NEW**  
LOCK & RIDE  
FALL AVAILABILITY  
REAR BED  
STORAGE RACK

» 2885113  
POLARIS GENERAL XP 1000/4 '20-21  
POLARIS GENERAL 1000/4 '16-21  
See P. 18 for more info

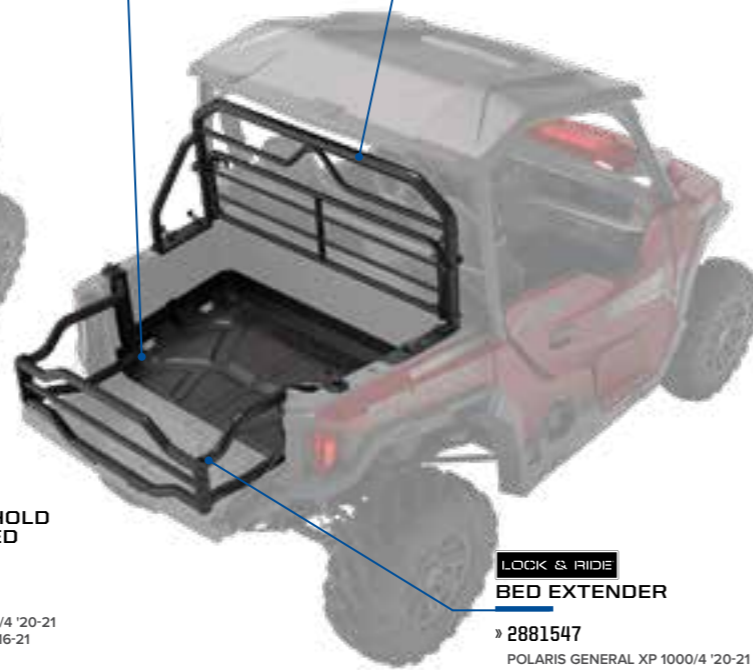

**CARGO  
BED MAT**

» 2881933  
POLARIS GENERAL XP 1000/4 '20-21  
POLARIS GENERAL 1000/4 '16-21

**LOCK & RIDE  
TIP-DOWN  
HEADACHE RACK**

» 2882144  
POLARIS GENERAL XP 1000/4 '20-21  
POLARIS GENERAL 1000/4 '16-21

**NEW**  
LOCK & RIDE  
FALL AVAILABILITY  
KOLPIN STRONGHOLD  
MOUNT - REAR BED  
STORAGE RACK

» 2885114  
POLARIS GENERAL XP 1000/4 '20-21  
POLARIS GENERAL 1000/4 '16-21  
See P. 18 for more info

**LOCK & RIDE  
BED EXTENDER**

» 2881547  
POLARIS GENERAL XP 1000/4 '20-21  
POLARIS GENERAL 1000/4 '16-21



**LOCK & RIDE  
SPARE TIRE CARRIER**

» 2881529  
POLARIS GENERAL XP 1000/4 '20-21  
POLARIS GENERAL 1000/4 '16-21  
FITS WHEEL UP TO 30"



**BEHIND SEAT  
STORAGE BAG**

» 2882164  
POLARIS GENERAL XP 1000/4 '20-21  
POLARIS GENERAL 1000/4 '16-21



**IN-DASH  
STORAGE BAG**

» 2882165  
POLARIS GENERAL XP 1000/4 '20-21  
POLARIS GENERAL 1000/4 '16-21



Ample storage with  
multiple openings for  
ease & convenience

## POLARIS ENGINEERED ADVANTAGES



**LOCK & RIDE**

**REVOLUTIONARY  
INSTALLATION**



**LOCK & RIDE  
CARGO BOX**

» 2881527  
POLARIS GENERAL XP 1000/4 '20-21  
POLARIS GENERAL 1000/4 '16-21  
Includes all mounting hardware for secure installation

**LOCK & RIDE  
D-RINGS**

» 2881545  
POLARIS GENERAL XP 1000/4 '20-21  
POLARIS GENERAL 1000/4 '16-21



**NOT SHOWN FIRE  
EXTINGUISHER HOLDER**

» 2882158  
POLARIS GENERAL XP 1000/4 '20-21  
POLARIS GENERAL 1000/4 '16-21  
Fits most 8.25 cm fire extinguishers (not included)



**EASILY  
RECONFIGURE  
FOR ANY TASK  
OR ANY TRAIL**



ACCESSORIES

WINDSHIELDS &  
REAR PANELS

DOORS

ROOFS &  
PROTECTION

STORAGE, CAB  
COMFORT & HUNT

COOLERS

RIDE COMMAND  
& AUDIO

LIGHTING

WHEELS & TIRES

WINCHES & PLOWS

# CAB COMFORT



## 8-VENT HEATER & DEFROST SYSTEM TOP SELLER



» 2881316

POLARIS GENERAL XP 1000/4 '20-21  
POLARIS GENERAL 1000/4 '16-21

Not Compatible with Rockford Fosgate Stage 4 Audio Kits

Audio Bracket (2885112) required to install heater on vehicles with Ride Command and audio, sold separately

## WINDSHIELD WIPER & WASHER SYSTEM TOP SELLER



» 2881090

POLARIS GENERAL XP 1000/4 '20-21  
POLARIS GENERAL 1000/4 '16-21

*See P. 08  
for windshields*



## CONVEX REAR VIEW MIRROR

» 2881540

POLARIS GENERAL XP 1000/4 '20-21  
POLARIS GENERAL 1000/4 '16-21



## FLOOR MATS

» 2881934

POLARIS GENERAL XP 1000/4 '20-21  
POLARIS GENERAL 1000/4 '16-21



- Red light is great for reading maps
- Green light is perfect for navigating in the dark
- Blue light is ideal for night riding

## MULTI-FUNCTION CAB LIGHT



- LED dome light provides white, red, green and blue lighting options
- Battery-operated, recharges when vehicle is on
- Remove to use as flashlight in and around vehicle

» 2884047

POLARIS GENERAL XP 1000/4 '20-21  
POLARIS GENERAL 1000/4 '19-21

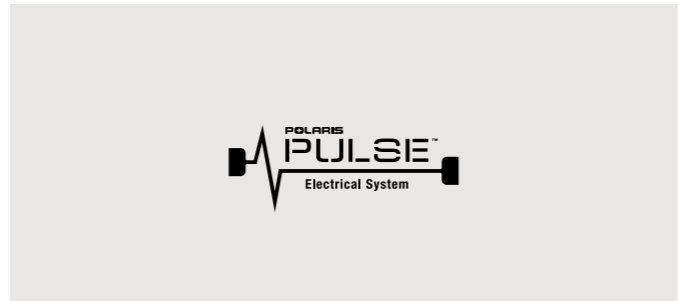

## POLARIS PULSE LED LIGHT BAR HARNESS



- Required to easily add electric components

» 2883785

POLARIS GENERAL XP 1000/4 '20-21  
POLARIS GENERAL 1000/4 '19-21

## POLARIS ENGINEERED ADVANTAGES



## ELECTRICAL INSTALLS MADE EASY WITH PLUG & PLAY

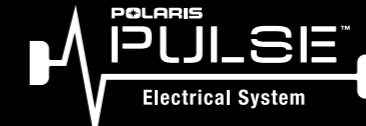

Look for to identify Polaris PULSE ready accessories.

- To install accessories, simply plug the harness into the Polaris PULSE hub
- No need to remove nuts and stack wire terminals like a three-post terminal setup
- By plugging in your accessories, a secure connection is guaranteed every time

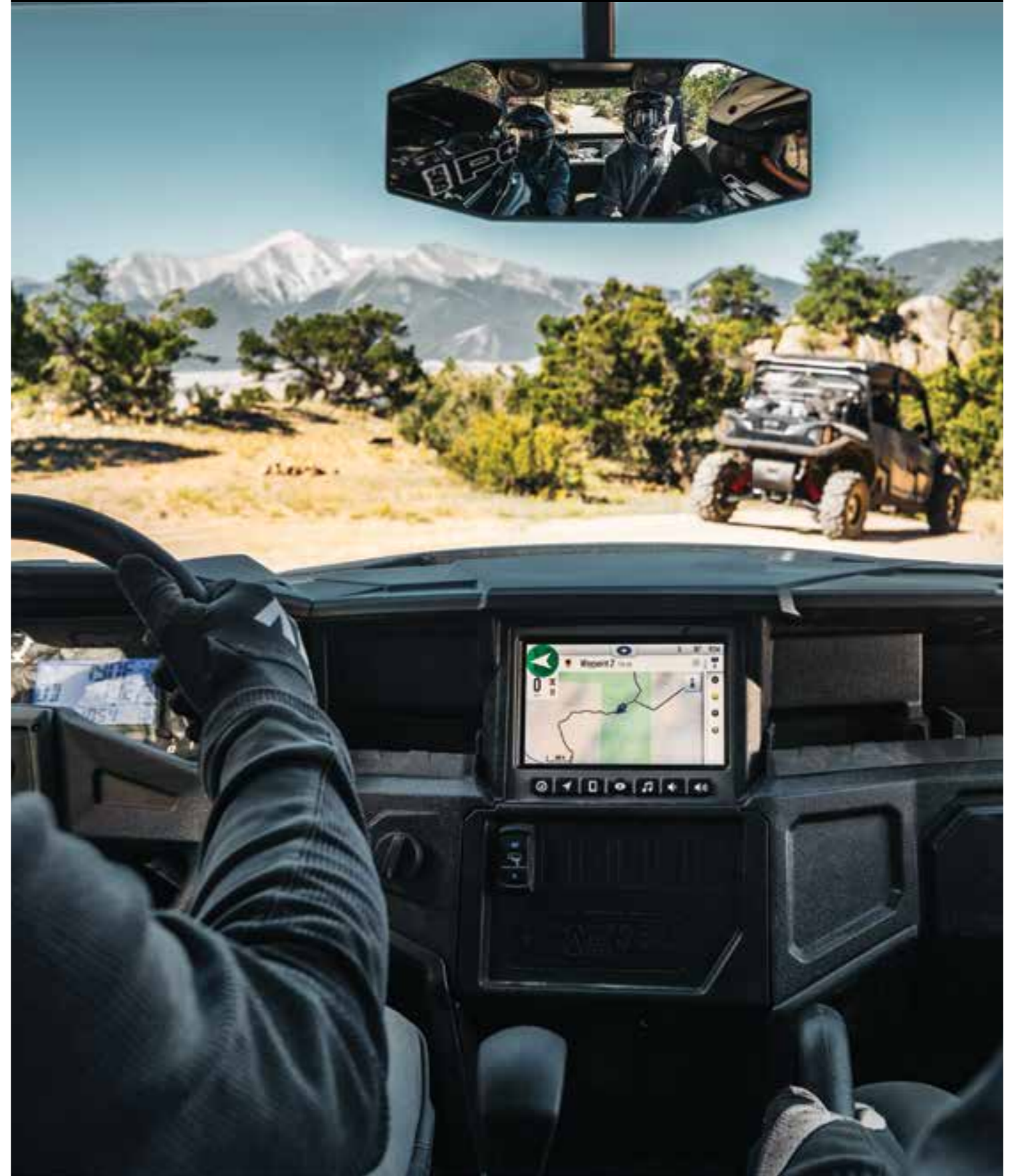

ACCESSORIES

WINDSHIELDS & REAR PANELS

DOORS

ROOFS & PROTECTION

STORAGE, CAB COMFORT & HUNT

COOLERS

RIDE COMMAND & AUDIO

LIGHTING

WHEELS & TIRES

WINDSHES & PLOWES

# HUNT

**KOLPIN**  
OUTDOORS

**PROTECTING  
YOUR  
ESSENTIAL  
GEAR SINCE  
1943**



## STORAGE



**NEW**

LOCK & RIDE FALL AVAILABILITY

### REAR BED STORAGE RACK

- Take more gear with 2 Kolpin Stronghold XL mounts and integrated MOLLE panels
- 30 or 60 Qt. Polaris Coolers will still fit in bed with rack installed

» 2885113

POLARIS GENERAL XP 1000/4 '20-21  
POLARIS GENERAL 1000/4 '16-21

**NEW**

LOCK & RIDE FALL AVAILABILITY

### KOLPIN STRONGHOLD MOUNT - REAR BED STORAGE RACK

- Kolpin Stronghold mount for attaching gun boots or other Kolpin Stronghold items to a General Rear Rack

» 2885114

POLARIS GENERAL XP 1000/4 '20-21  
POLARIS GENERAL 1000/4 '16-21

## KOLPIN STRONGHOLD CASES



### KOLPIN STRONGHOLD GUN BOOTS

» XL TRANSPORT • 2882430\*

POLARIS GENERAL XP 1000/4 '20-21  
POLARIS GENERAL 1000/4 '16-21

» L IMPACT • 2882426\*

POLARIS GENERAL XP 1000/4 '20-21  
POLARIS GENERAL 1000/4 '16-21



### KOLPIN STRONGHOLD AUTO-LATCH MOUNT

» 2884106

POLARIS GENERAL XP 1000/4 '20-21  
POLARIS GENERAL 1000/4 '16-21



### KOLPIN STRONGHOLD POP-UP BLIND/ICE AUGER BOOT

» 2882427\*

POLARIS GENERAL XP 1000/4 '20-21  
POLARIS GENERAL 1000/4 '16-21

## KOLPIN RHINO GRIPS IDEAL FOR BOWS & UNCASSED GUNS

LOCK & RIDE

### RHINO GRIP PRO

» 2884107

POLARIS GENERAL XP 1000/4 '20-21  
POLARIS GENERAL 1000/4 '16-21

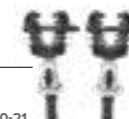

LOCK & RIDE

### RATCHETING RHINO GRIP

» 2881575

POLARIS GENERAL XP 1000/4 '20-21  
POLARIS GENERAL 1000/4 '16-21



LOCK & RIDE

### RHINO GRIP XLR

» 2881574 • SINGLE

POLARIS GENERAL XP 1000/4 '20-21  
POLARIS GENERAL 1000/4 '16-21

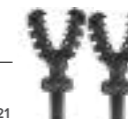

LOCK & RIDE

### RHINO GRIP XLR - DOUBLES

» 2884108

POLARIS GENERAL XP 1000/4 '20-21  
POLARIS GENERAL 1000/4 '16-21



**NEW**

### HEAVY-DUTY XLR REPLACEMENT RUBBER STRAPS (2)

» 2889204

POLARIS GENERAL XP 1000/4 '20-21  
POLARIS GENERAL 1000/4 '16-21



### RHINO GRIP PRO RUBBER STRAPS

» 2884109

POLARIS GENERAL XP 1000/4 '20-21  
POLARIS GENERAL 1000/4 '16-21



**KEEP IT  
ICE COLD**



**GRIZZLY TESTED.  
POLARIS APPROVED.**



This cooler is IGBC-approved, meaning it withstands the power expended by a typical grizzly bear if it was trying to get inside.

Seriously, there are experts who know what a grizzly is capable of doing, and they certify our coolers can take it.



**28, 57 & 99  
LITER FEATURES**



ComfortCarry Handles



TravelLock System



EasyOut Drain System



NoSlip Rubber Feet



PolarWall Insulation



IceLock Seal

**POLARIS NORTHSTAR COOLERS CAN SURVIVE JUST ABOUT ANYTHING - FROM EXTREME HEAT TO A NASTY TUMBLE OFF A VEHICLE.**



**99 LITER**

- » GRAPHITE • 2883426
- » DESERT • 2883392



**57 LITER**

- » GRAPHITE • 2883425
- » DESERT • 2881259



**28 LITER**

- » GRAPHITE • 2883424
- » DESERT • 2881315



**14 LITER**











- » GRAPHITE • 2883968



**19 LITER SOFTSIDE**

- » GRAPHITE • 2883390

**ESSENTIAL ACCESSORIES SO YOUR COOLER WORKS AS HARD AS YOU DO**

COOLER ACCESSORIES		99 LITER	57 LITER	28 LITER	DON'T FORGET THESE ACCESSORIES		
	<b>WIRE BASKET</b>	2883648	2882185	2882438			
	<b>DIVIDERS</b> Doubles as cutting board	2883468 COMES WITH ONE DIVIDER  1 way to partition	2882184 COMES WITH TWO DIVIDERS  2 ways to partition	2882186 COMES WITH ONE DIVIDER  1 way to partition	<b>TUMBLERS</b>	<b>LOCK &amp; RIDE QUICKSTRAP</b>	<b>BOTTLE OPENER</b>
	<b>SEAT CUSHION</b>	NOT AVAILABLE	2882179	2882507	» 887 mL • 2883394 » 591 mL • 2883393	» 2882187 ALL COOLERS AND POLARIS GENERAL CARGO BOXES	» 2882183 ALL COOLERS
	<b>WHEELS</b>	2883967	2882180	NOT AVAILABLE			

# RIDECOMMAND

- BUILT-IN GPS WITH TOPOGRAPHY MAPS TO SEE YOUR LOCATION AND PLAN YOUR RIDE
- MEDIA PLAYER WITH BUILT IN AM/FM TUNER FOR ALL YOUR FAVORITE MUSIC
- GROUP RIDE FOR BUDDY TRACKING, TO SEE YOUR FRIENDS ON THE MAP, TRACK AND SHARE RIDE STATS ON THE DISPLAY OR RIDE COMMAND MOBILE APP

## REVOLUTIONIZING THE OFF-ROAD EXPERIENCE

### RIDE COMMAND 7" DISPLAY

- 7" High Bright Touchscreen visible in all conditions
- Displays critical vehicle information for fuel level, coolant temp and battery voltage
- Media player with built in AM/FM tuner\*
- Enhanced Group Ride capability to track and share your ride
- Dedicated shortcut buttons for quick access to features
- Bluetooth and USB smart phone connectivity
- Front camera support for better visibility on and off trail

» 2884072  
POLARIS GENERAL XP 1000/4 '20-21  
POLARIS GENERAL 1000/4 '19-21

### RIDE COMMAND MOUNT KIT

- Mount Ride Command seamlessly into the dash for perfect fit and finish
- Comes with wiring harnesses needed and accessory components
- Includes front and rear camera, V2V, and GPS antenna

» 2884283  
POLARIS GENERAL XP 1000/4 '20-21  
POLARIS GENERAL 1000/4 '20-21

### NEW AUDIO BRACKET

- Used to mount audio amplifier for front and rear speakers when subwoofer is removed
- Required to install a heater on a vehicle with Ride Command and audio

» 2885112  
POLARIS GENERAL XP 1000/4 '20-21  
POLARIS GENERAL 1000/4 '20-21

DOWNLOAD THE RIDE COMMAND MOBILE APP



# AUDIO



- PLUG AND PLAY
- ELEMENT READY
- NO LOSS OF CARGO SPACE
- BLUETOOTH CAPABLE

An industry first. A true factory installed integrated off-road audio system. Rockford Fosgate partnered with Polaris to purpose build the highest performing system specifically for the GENERAL platform. Tuned and rider-centric to create a class leading audio experience that is second to none.



### STAGE 1 AUDIO KIT

- PMX-P2 HEAD UNIT & FRONT COAXIAL SPEAKERS
  - 16.51 cm 6.86 cm full color display with AM/FM/WB tuner\*, Pandora Control and Bluetooth Connectivity
  - 50 Watt 16.51 cm front coaxial speakers with enclosures and grilles
- » 2884282  
POLARIS GENERAL XP 1000/4 '20-21  
POLARIS GENERAL 1000/4 '20-21



### NEW STAGE 2 PMX AUDIO KIT + REAR SPEAKERS

- REAR COAXIAL SPEAKERS & AMP
  - 2, 50 Watt 16.51 cm rear coaxial speakers with enclosures and grilles
  - 400 Watt 4-channel full range amplifier
  - IP67 Rating delivering water resistance and dust protection
- » 2885162  
POLARIS GENERAL XP 1000/4 '20-21  
POLARIS GENERAL 1000/4 '16-21



### NEW STAGE 2 RIDE COMMAND AUDIO KIT + REAR SPEAKERS

- FRONT & REAR COAXIAL SPEAKERS & AMP
  - 2, 50 Watt 16.51 cm front and rear coaxial speakers with enclosures and grilles
  - 400 Watt 4-channel full range amplifier
  - IP67 Rating delivering water resistance and dust protection
- » 2885163  
POLARIS GENERAL XP 1000/4 '20-21  
POLARIS GENERAL 1000/4 '16-21  
REQUIRES RIDE COMMAND 7" DISPLAY 2884072 & MOUNT KIT 2884283 (BOTH SOLD SEPARATELY)



### NEW STAGE 4 UPGRADE

- SUBWOOFER
  - Compatible with Stage 1 and Stage 2 PMX-P2 Audio Kits
  - 200 Watt 16.51 cm subwoofer
- » 2889053  
POLARIS GENERAL XP 1000/4 '20-21  
POLARIS GENERAL 1000/4 '16-21

## BUILD YOUR SOUND

	HEAD UNIT: PMX-P2	RIDE COMMAND
AUDIO:	STAGE 1 AUDIO KIT	STAGE 4 RIDE COMMAND AUDIO KIT
MODEL FITMENT:		
XP	FACTORY INSTALLED STOCK AUDIO	
DELUXE	STAGE 1 AUDIO KIT WITH PMX-P2 HEAD UNIT	RIDE COMMAND + STAGE 4 AUDIO SYSTEM UPGRADE PACKAGE INSTALLED
PREMIUM	STAGE 1 AUDIO KIT PMX HEAD UNIT + FRONT COAXIAL SPEAKERS 2884282	RIDE COMMAND 2884072 + MOUNT KIT 2884283 2020-2021 MODELS
SPORT	STAGE 2 + REAR SPEAKERS UPGRADE REAR SPEAKERS, AMP + AUDIO BRACKET 2885162	STAGE 2 UPGRADE REAR SPEAKERS, AMP + AUDIO BRACKET 2885163
	+ OPTIONAL SUBWOOFER	STAGE 4 UPGRADE SUBWOOFER 2889053
	NOT COMPATIBLE WITH 8-VENT HEATER & DEFROST SYSTEM (2881316)	NOT COMPATIBLE WITH 8-VENT HEATER & DEFROST SYSTEM (2881316)

\*The FM Frequency range is from 88 to 108 and only on the odds (i.e. 88.1, 88.3, etc).

ACCESSORIES

WINDSHIELDS & REAR PANELS

DOORS

ROOFS & PROTECTION

STORAGE, CAB COMFORT & HUNT

COOLERS

RIDE COMMAND & AUDIO

LIGHTING

WHEELS & TIRES

WINCHES & PLOWS



**POLARIS ENGINEERED ADVANTAGES**

**MOUNTS PERFECTLY**  
Designed for your Polaris Engineered bumper, roof or other mounting point

**MAX PERFORMANCE**  
Validated to work as hard as your machine does

**DOESN'T OVERTAX**  
Trust it to work when you need it to

**PRO ARMOR**



**ADVANCED TECH**

RIGID lights are driven by Aluminum PCB Smart Boards, 6063-T5 aircraft aluminum extruded housings and Tiger Drylac UV protection polyester powdercoating.

**EXCLUSIVE OPTICS**

RIGID invests heavily in optical science and has patented multiple optics and optics systems, maximizing light output and efficiency.

**RUGGED CONSTRUCTION**

Pro Armor lights are designed to be big and beefy with an aggressive style all their own, and housed in IP67 marine-grade rated UV polyester powdercoating.

**MASSIVELY BRIGHT**

Pro Armor builds bright lights designed for any riding experience. All that power is directed through heat dissipating aluminum for streamlined heat management.

**LIGHT BAR TYPES**



**SR-SERIES PRO**

Sleek, powerful, low-profile (under 5 cm tall). Lights extreme distances with low energy usage. Available in 25.4 cm & 81.3 cm



**D-SERIES PRO**

Compact to fit almost anywhere with high output and low energy usage. Available in Driving, Flood & Spot



**DUAL-ROW LED LIGHT BARS**

The most spread and farthest illumination downrange. Easy to mount. Available in Cube, 25.4 cm, 50.8 cm & 76.2 cm



**SINGLE-ROW LED LIGHT BARS**

Powerful, compact, low-profile light bars with sleek look. Available in 27.9 cm, 83.8 cm & 101.6 cm



**CUBE LED LIGHTS**

Small size allows mounting in strategic locations for added lighting. Available in Flood & Spot

**LIGHT BAR OPTIONS**

**OPTICS DRIVING FLOOD**

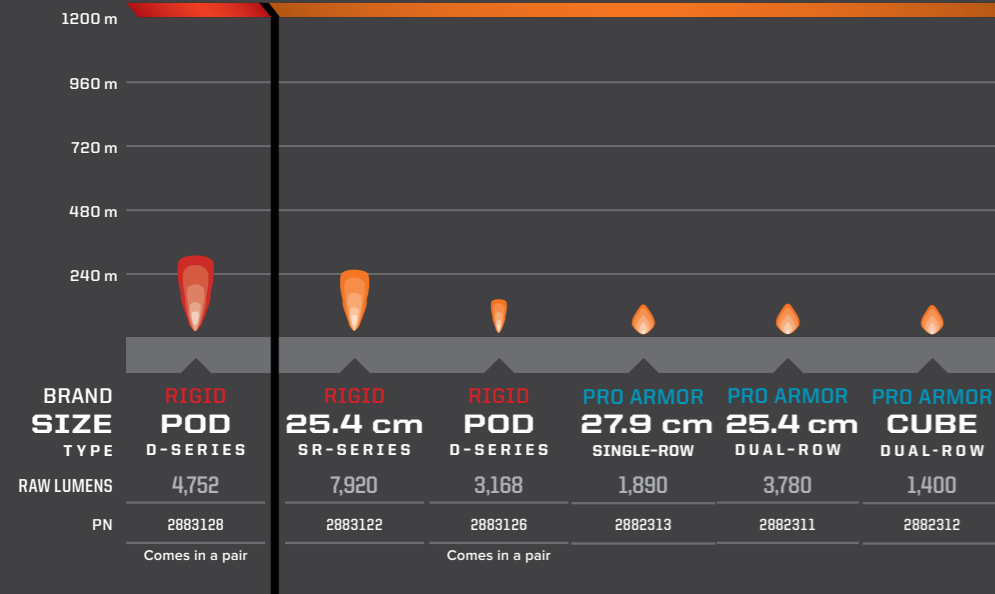

**SPOT**

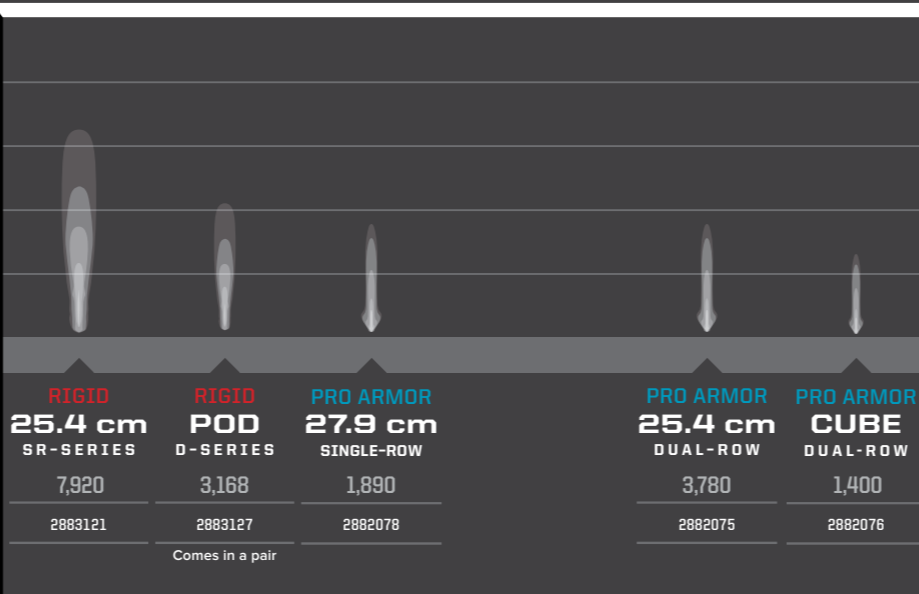

**COMBO**

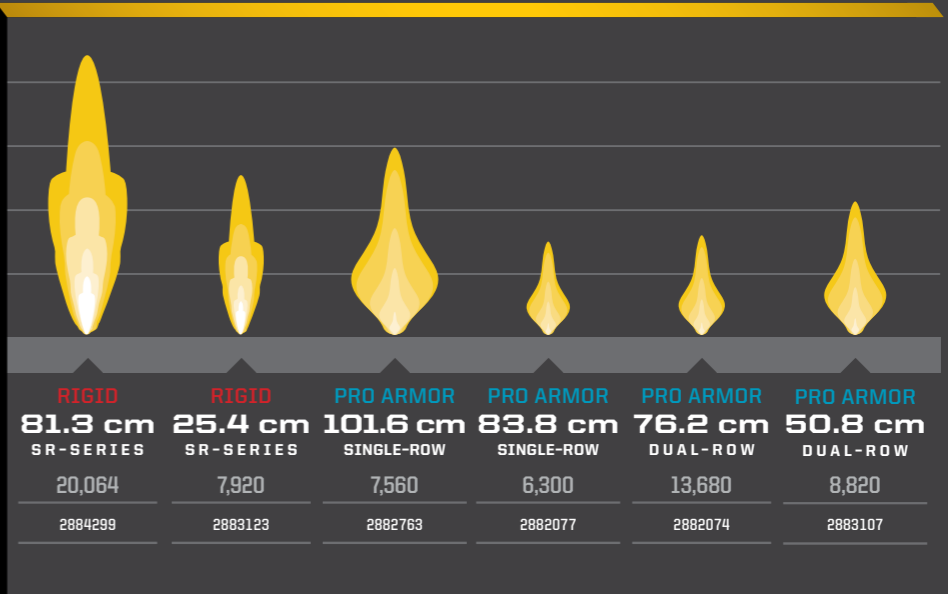

**OPTICS**

**BUILD YOUR VISION**

Consider the Optics, Angle & how you will use your vehicle to choose the right light or set of lights.

OPTICS LIGHT ANGLE	ACCENT	DRIVING (45°)	FLOOD (25°)	SPOT (10°)	COMBO (25°/10°)
DRIVING SPEED	All	Slow	Medium	Fast	Medium to fast
BEAM	Diffused glow	Extra-wide	Wide/Shorter	Concentrated/Long	Inner spot & outer flood
RECOMMENDED MOUNTING	Low/Wheel well	All points	Low &/or rear	High points	All points
TERRAIN & RIDING STYLE	Added style & personalization in any terrain	All riding & utility	Wide-open terrain or trails & utility	Trail & tight conditions	All riding & utility

**ADD A HARNESS TO MOUNT YOUR LIGHTS**

MODEL	LIGHT BAR SET-UPS		
	1 LIGHT IN 1 LOCATION ON 1 SWITCH	2 LIGHTS IN 2 LOCATIONS ON 1 SWITCH	2 LIGHTS IN 2 LOCATIONS ON 2 SWITCHES
2019-2020 ALL MODELS	POLARIS PULSE LED LIGHT BAR HARNESS 2883785	POLARIS PULSE LED LIGHT BAR HARNESS 2883785 Y-HARNESS 2879860	POLARIS PULSE LED LIGHT BAR HARNESS (x2) 2883785

**ACCENT LIGHTING**

**ACCENT LIGHTS**

POLARIS GENERAL XP 1000/4 '20-21  
POLARIS GENERAL 1000/4 '16-21

COLOR	PN
RED (SET OF 4)	2880500
BLUE (SET OF 4)	2880506

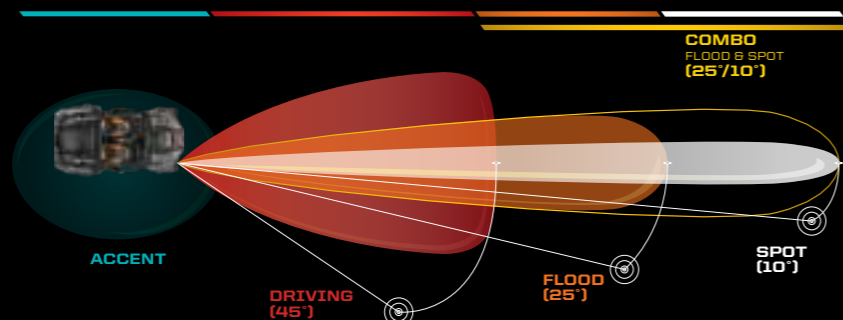

▲ No battery connection cables required on any model/model year POLARIS GENERAL 1000.

All RIGID and Pro Armor lights are Polaris PULSE ready.

ACCESSORIES

WINDSHIELDS & REAR PANELS

DOORS

ROOFS & PROTECTION

STORAGE CAB COMFORT & HUNT

COOLERS

RIDE COMMAND & AUDIO

LIGHTING

WHEELS & TIRES

WINCHES & PLOWES

# KNOW YOUR TERRAIN



- Tread patterns optimized for extreme traction
- Ideal for both hard pack and loose trail



- Flexible "grippy" tread
- Aggressive side bite



- Provides traction and durability
- Built to perform in hard sand, jagged rocks or any other extreme terrain



- Extra deep treads
- Self-cleaning lugs



- Paddles provide traction and durability in soft sand
- Built to float on top of sand



- Industry leading anti-puncture side walls
- Purpose-built, long lasting tread patterns



- Handles extreme cold
- Holds shape and provides traction

# SUPERIOR PERFORMANCE & DURABILITY

# WAYS TO SHOP WHEELS & TIRES



## LIFELONG PERFORMANCE

- Every tire is designed and constructed with longevity in mind
- 3,000+ mile rated (4,828 kilometers)

## PREMIUM PROTECTION

- Pro Armor makes tires with extra protection exactly where it's needed most—the sidewall
- Triple-belted sidewalls keep your tires more resistant so you can keep going

## TOUGHEST TIRES

- Higher ply ratings mean added protection
- Pro Armor builds 8 or 10-ply rated tires for higher puncture-resistance



## KNOW YOUR TIRES

DIMENSIONS			TREAD DEPTH	TIRE WEIGHT	PLY RATING	SIDEWALL BELTS	LOAD RATING
TIRE HEIGHT	TIRE WIDTH	WHEEL DIAMETER					
32" x 9"	R15	FRONT/REAR	30 mm	18 kg	10	3	499 kg
Part Number			<b>TREAD DEPTH</b> Deeper treads have more grip in all conditions	<b>PLY RATING</b> Indicates tire puncture-resistance	<b>LOAD RATING</b> How much weight can the tire handle	<b>USAGE</b> Where can you use the tire	<b>TIRE WEIGHT</b> A lighter tire makes for improved vehicle performance
			<b>SIDEWALL BELTS</b> Increase your resistance to sidewall punctures				

## TIRES BY SIZE

27"	28"	29"	30"
MUD XC	HARVESTER	DUAL-THREAT	CRAWLER XG
HARVESTER	CRAWLER XR	MUD XC	ATTACK 2.0
	ATTACK 2.0	HD-K	HARVESTER
	CRAWLER XG		CRAWLER XG

## TIRES BY TERRAIN

TRAIL	ROCK	DESERT	MUD	UTILITY	SNOW
CRAWLER XR	CRAWLER XR	CRAWLER XR	MUD XC	HARVESTER	ATTACK 2.0
CRAWLER XG	CRAWLER XG	CRAWLER XG		PRESERVE	ATTACK
MUD XC	DUAL-THREAT	ATTACK 2.0		XD-K	HARVESTER
ATTACK 2.0	ATTACK 2.0	ATTACK		HD-K	XD-K
ATTACK		DUAL-THREAT			HD-K
DUAL-THREAT					
HARVESTER					
PRESERVE					
XD-K					
HD-K					

## WHEELS BY SIZE

14"	15"
40-SERIES (7 TIRE OPTIONS)	50-SERIES (6 TIRE OPTIONS)
4201 (AMPLIFY)	5201 (CYCLONE)
4202 (BUCKLE)	5202 (FLARE)
4301 (COMBAT)	5301 (HALO)
4203 (REBLR)	5203 (HEXLR)
4204 (SHACKLE)	5204 (WYDE)
4205 (SIXR)	
HD DUAL BEADLOCK	

## KNOW YOUR WHEELS

### STEP 1: SELECT YOUR SERIES

4 = 40-SERIES 5 = 50-SERIES

### STEP 2: CHOOSE YOUR LOAD RATING

1 = <800 LBS 2 = 801 - 1,300 LBS 3 = 1,301 - 1,600+ LBS

### STEP 3: PICK YOUR STYLE

OFFSET / BEADLOCK / COLOR

INCREASE OFFSET FROM STOCK = NARROWER STANCE  
DECREASE OFFSET FROM STOCK = WIDER STANCE

# TIRES



FRONT/REAR

## PRO ARMOR CRAWLER XR

- Wanna race? This tire grips it all from the trail to the rocks
- Square block profile for even surface contact
- A tougher durometer than the XG to take on the toughest the trail has to offer

		TREAD DEPTH	TIRE WEIGHT	PLY RATING	SIDEWALL BELTS	LOAD RATING	
14"	<b>28" x 10" R14</b> 5415536	FRONT/REAR	16 mm	15 kg	8	3	517 kg



WHEEL SIZE



## XR

### SINGLE DUROMETER

- Smaller lug height, added rigidity and lateral stability when cornering
- Unique lug design excels in hard-packed, fast terrain



FRONT/REAR

## PRO ARMOR ATTACK 2.0

- Engineered for excellent hard-pack performance
- Dual-compound technology and radial construction offer performance in all terrains
- Tight thread pattern for a quieter ride

		TREAD DEPTH	TIRE WEIGHT	PLY RATING	SIDEWALL BELTS	LOAD RATING	
18"	<b>28" x 10" R15</b> 5416344	FRONT/REAR	25 mm	15 kg	10	3	503 kg
15"	<b>30" x 10" R15</b> 5416345			17 kg			560 kg



WHEEL SIZE



TIGHTER TREAD PATTERN = Better traction in hard pack

DUAL-DUROMETER LUG = Increased grip & traction in rough terrain, smoother

10-PLY RATED = Increased durability

LARGER SIZE OFFERING IN 28" = More ground clearance & trail traction



FRONT/REAR

## PRO ARMOR CRAWLER XG

- Big or small, these tires crawl them all
- A soft, sticky compound makes this tire ideal for both rock crawling and desert running
- 8-ply, triple-belted ballistic sidewalls resist punctures

		TREAD DEPTH	TIRE WEIGHT	PLY RATING	SIDEWALL BELTS	LOAD RATING	
14"	<b>30" x 10" R14</b> 5415616		17 kg			581 kg	
15"	<b>28" x 10" R15</b> 5416346	FRONT/REAR	20 mm	15 kg	8	3	498 kg
15"	<b>30" x 10" R15</b> 5416397		18 kg			581 kg	



WHEEL SIZE

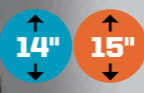

## WHAT CRAWLER ARE YOU?

## XG

### DUAL-DUROMETER

- Taller lug height
- Perfect balance between high-speed performance, durability and flex in order to grip slick rock



FRONT/REAR

## PRO ARMOR ATTACK

- The best all-purpose tire for all-season traction in any terrain
- Unique, full-face tread design
- Harder durometer lugs promote extended wear, increasing tire life
- Wider spaced lugs provide more grip in softer terrain

		TREAD DEPTH	TIRE WEIGHT	PLY RATING	SIDEWALL BELTS	LOAD RATING	
14"	<b>26" x 9" R14</b> 5415613	FRONT	23 mm	13 kg	8	3	413 kg
14"	<b>26" x 11" R14</b> 5415614	REAR		15 kg			599 kg



WHEEL SIZE



FRONT/REAR

## PRO ARMOR DUAL-THREAT

- Dual-compound technology and radial construction offer performance in all terrains
- Softer durometer rubber on outer edge for overall superior grip and feel
- Harder durometer rubber in the middle for increased traction during acceleration and longer tread life

		TREAD DEPTH	TIRE WEIGHT	PLY RATING	SIDEWALL BELTS	LOAD RATING	
14"	<b>26" x 9" R14</b> 5416340	FRONT	16 mm	12 kg	10	3	413 kg
14"	<b>26" x 11" R14</b> 5416341	REAR		14 kg			499 kg
14"	<b>29" x 9" R14</b> 5416342	FRONT		14 kg			499 kg
14"	<b>29" x 11" R14</b> 5416343	REAR		16 kg			599 kg



WHEEL SIZE



## DUAL-COMPOUND = MORE GRIP + LONGER LIFE



- 1 Firmer Durometer Rubber = Longer Life
- 2 Softer Durometer Rubber = More Grip



FRONT/REAR

## PRO ARMOR MUD XC

- Designed for the perfect mud-trail crossover for a smooth ride on the trail and aggressive traction in the mud
- Dual-compound technology with harder durometer lugs promote extended wear, increasing tire life
- 10-ply construction, means added protection in the toughest terrain

		TREAD DEPTH	TIRE WEIGHT	PLY RATING	SIDEWALL BELTS	LOAD RATING	
14"	<b>29" x 10" R14</b> 5416946	FRONT/REAR	30 mm	18 kg	10	3	630 kg
14"	<b>27" x 9" R14</b> 5416947	FRONT		14 kg			531 kg
14"	<b>27" x 11" R14</b> 5416948	REAR		15 kg			599 kg



WHEEL SIZE





## PICKING THE RIGHT UTILITY TIRE

UTILITY FEATURE	HARVESTER	PRESERVE	XD-K	HD-K
<b>8,047 Kilometer Rated</b> Long life and performance	X	X		
<b>10-Ply Rated</b> Higher ply ratings means added protection	X	X	X	X
<b>Low Impact Tread</b> Easy on soil		X		
<b>Heavy Duty Tread</b> Aggressive tread pattern for all day work on farms or ranches	X		X	X
<b>Turf-Friendly</b> Easy on grass and farm yard	X	X		
<b>Aramid Fiber Belt</b> 5x times stronger than steel and lighter			X	X
<b>Wide Range of Sizes</b> For exactly how you want to use your machine	30", 28", 27", 26"	27", 26"	26"	29"



### PRO ARMOR PRESERVE

- Turf-friendly for areas where low-impact from tire tread is needed
- Rounded profile and special tread pattern to limit footprint

	TREAD DEPTH	TIRE WEIGHT	PLY RATING	SIDEWALL BELTS	LOAD RATING
12" 26" x 8" R12 5416403	FRONT	11 kg			388 kg
12" 26" x 10" R12 5416402	REAR	13 kg	10	3	599 kg
14" 27" x 10" R14 5416348	FRONT/REAR	13 kg			599 kg



WHEEL SIZE  
14" 12"



### PRO ARMOR HARVESTER

- All-around work horse with tread life of 8047 km
- Tread pattern designed to withstand anything from the farmyard to the pastures and the trail
- With 10-ply, it can carry the load day in and day out

	TREAD DEPTH	TIRE WEIGHT	PLY RATING	SIDEWALL BELTS	LOAD RATING
12" 26" x 8" R12 5416396	FRONT	11 kg			388 kg
12" 26" x 10" R12 5415966	REAR	15 kg			615 kg
14" 27" x 10" R14 5415965	FRONT/REAR	15 kg	10	3	599 kg
14" 28" x 10" R14 5416347	FRONT/REAR	15 kg			630 kg
15" 30" x 10" R15 5417529	FRONT/REAR	17 kg			599 kg



WHEEL SIZE  
15" 14" 12"



### PRO ARMOR XD-K

- 26" Aramid fiber-belted tire to tackle any terrain
- Unique full-face tread design
- Harder durometer lugs promotes extended wear, increasing tire life

	TREAD DEPTH	TIRE WEIGHT	PLY RATING	SIDEWALL BELTS	LOAD RATING
12" 26" x 9" R12 5415756	FRONT	13 kg			388 kg
12" 26" x 11" R12 5415757	REAR	15 kg	10	3/1 Aramid	499 kg



WHEEL SIZE  
12"



### PRO ARMOR HD-K

- Designed to provide a smooth ride and aggressive traction in all riding terrains
- Triple belted sidewall provides extreme sidewall protection and extends the tire life
- Quad belt tread core offers superior protection and longer tread life

	TREAD DEPTH	TIRE WEIGHT	PLY RATING	SIDEWALL BELTS	LOAD RATING
14" 29" x 10" R14 5417507	FRONT/REAR	18 kg	10	3/1 Aramid	598 kg



WHEEL SIZE  
14"

# WHEELS



## 40-SERIES

### A 4201 (AMPLIFY) ○

FRONT WEIGHT: 5.9 kg | LOAD RATING: 408 kg | OFFSET: +4  
 REAR WEIGHT: 6.4 kg | LOAD RATING: 590 kg | OFFSET: -9  
**ACCENT:** FRONT 14" x 7" 1522956-266  
 REAR 14" x 8" 1522957-266  
**MATTE BLACK:** FRONT 14" x 7" 1522956-458  
 REAR 14" x 8" 1522957-458

### E 4202 (BUCKLE) ○

FRONT WEIGHT: 5.8 kg | LOAD RATING: 408 kg | OFFSET: +4  
 REAR WEIGHT: 6.1 kg | LOAD RATING: 590 kg | OFFSET: -9  
**ACCENT:** FRONT 14" x 7" 1522544-266  
 REAR 14" x 8" 1522545-266  
**MATTE BLACK:** FRONT 14" x 7" 1522544-458  
 REAR 14" x 8" 1522545-458

### C 4301 BEADLOCK (COMBAT)

FRONT/REAR WEIGHT: 7.3 kg | LOAD RATING: 729 kg | OFFSET: +38  
**ACCENT:** FRONT/REAR 14" x 7" 1523284  
**MATTE BLACK:** FRONT/REAR 14" x 7" 1523283

### D 4203 BEADLOCK (REBLR) ○

FRONT WEIGHT: 5.9 kg | LOAD RATING: 408 kg | OFFSET: +4  
 REAR WEIGHT: 6.6 kg | LOAD RATING: 590 kg | OFFSET: -9  
**MATTE BLACK:** FRONT 14" x 7" 1522238-458  
 REAR 14" x 8" 1522239-458

### F 4204 (SHACKLE) ○

FRONT WEIGHT: 5.9 kg | LOAD RATING: 408 kg | OFFSET: +4  
 REAR WEIGHT: 6.4 kg | LOAD RATING: 590 kg | OFFSET: -9  
**ACCENT:** FRONT 14" x 7" 1522546-266  
 REAR 14" x 8" 1522547-266  
**MATTE BLACK:** FRONT 14" x 7" 1522546-458  
 REAR 14" x 8" 1522547-458

### G 4205 (SIXR) ○

FRONT WEIGHT: 4.8 kg | LOAD RATING: 408 kg | OFFSET: +4  
 REAR WEIGHT: 5.7 kg | LOAD RATING: 590 kg | OFFSET: -9  
**MATTE BLACK:** FRONT 14" x 7" 1521507-521  
 REAR 14" x 8" 1521508-521  
**LUSTER:** FRONT 14" x 7" 1521507-410  
 REAR 14" x 8" 1521508-410

### NEW HD DUAL BEADLOCK

FRONT/REAR WEIGHT: 18.1 kg | LOAD RATING: 725.7 kg | OFFSET: +38  
**MATTE BLACK:** FRONT/REAR 14" x 7" 1524022-458



#### 14" FORGED BEADLOCK RINGS

Only used on 4203 (REBLR) PART #

A	Voodoo Blue	1522244-619
B	Machined	1522244-266
C	White	1522244-133
D	Indy Red	1522244-293
E	Orange Crush	1522244-589

#### 15" FORGED BEADLOCK RINGS

Only used on 5203 (HEXLR) PART #

C	Matte Black - Replacement	1523147-458
---	---------------------------	-------------

## 50-SERIES

### H 5201 (CYCLONE)

FRONT/REAR WEIGHT: 7.8 kg | LOAD RATING: 590 kg | OFFSET: +4  
**ACCENT:** FRONT/REAR 15" x 7" 1523184-266  
**MATTE BLACK:** FRONT/REAR 15" x 7" 1523184-458

### I 5301 BEADLOCK (HALO)

FRONT/REAR WEIGHT: 7.7 kg | LOAD RATING: 726 kg | OFFSET: +38  
**ACCENT:** FRONT/REAR 15" x 7" 1523282  
**MATTE BLACK:** FRONT/REAR 15" x 7" 1523266

### J 5204 (WYDE) ○

FRONT/REAR WEIGHT: 6.1 kg | LOAD RATING: 590 kg | OFFSET: +55  
**MATTE BLACK:** FRONT/REAR 15" x 7" 1522550-458

### K 5202 (FLARE)

FRONT/REAR WEIGHT: 8.1 kg | LOAD RATING: 590 kg | OFFSET: +4  
**ACCENT:** FRONT/REAR 15" x 7" 1523102-266  
**MATTE BLACK:** FRONT/REAR 15" x 7" 1523102-458

### L 5203 BEADLOCK (HEXLR) ○

FRONT/REAR WEIGHT: 7.3 kg | LOAD RATING: 590 kg | OFFSET: +38  
**MATTE BLACK:** FRONT/REAR 15" x 7" 1522435-458

○ LUG NUTS REQUIRED

## KNOW YOUR WHEELS

### STEP 1: SELECT YOUR SERIES

4 = 40-SERIES 5 = 50-SERIES

### STEP 2: CHOOSE YOUR LOAD RATING

1 = <800 LBS 2 = 801 - 1,300 LBS 3 = 1,301 - 1,600+ LBS

### STEP 3: PICK YOUR STYLE

OFFSET / BEADLOCK / COLOR

INCREASE OFFSET FROM STOCK = NARROWER STANCE  
 DECREASE OFFSET FROM STOCK = WIDER STANCE

## KNOW YOUR TERRAIN



• Tread patterns optimized for extreme traction  
 • Ideal for both hard pack and loose trail



• Extra deep treads  
 • Self-cleaning lugs



• Industry leading anti-puncture side walls  
 • Purpose-built, long lasting tread patterns



• Flexible "grippy" tread  
 • Aggressive side bite

# WHEEL & TIRE SETS



## 40-SERIES

	TRAIL	MUD	UTILITY	ROCK
DUAL-THREAT 29" 4828 km	MUD XC 27" 4828 km	MUD XC 29" 4828 km	HARVESTER 27" 8047 km	HARVESTER 28" 8047 km
CRAWLER XG 30" 4828 km	CRAWLER XR 28" 4828 km			
4201 (AMPLIFY) Accent ○	2883146	2884272	2884265	2882388
4201 (AMPLIFY) Matte Black ○	2883147	2884273	2884266	2882389
4202 (BUCKLE) Accent ○	2883148	2884267	2884260	2882383
4202 (BUCKLE) Matte Black ○	2883149	2884268	2884261	2882384
4301 (COMBAT) Accent BEADLOCKS PRE-MOUNTED	2883219			2883220
4301 (COMBAT) Matte Black BEADLOCKS PRE-MOUNTED	2883218			2883221
4203 (REBLR) Matte Black BEADLOCKS SOLD SEPARATELY ○				2881561
4204 (SHACKLE) Accent ○	2883150	2884270	2884263	2883222
4202 (SHACKLE) Matte Black ○	2883151	2884271	2884264	2883223
4205 (SIXR) Luster ○				2881564
4205 (SIXR) Matte Black ○	2883152	2884269	2884262	2883224
				2881563
				2881371
				2881372



## 50-SERIES

	TRAIL	UTILITY	ROCK
ATTACK 2.0 28" 4828 km	ATTACK 2.0 30" 4828 km	HARVESTER 30" 8047 km	CRAWLER XG 28" 4828 km
CRAWLER XG 30" 4828 km			
5201 (CYCLONE) Accent	2883160	2883169	2883188
5201 (CYCLONE) Matte Black	2883159	2883168	2883187
5202 (FLARE) Accent	2883158	2883167	2885045
5202 (FLARE) Matte Black	2883157	2883166	2885046
5301 (HALO) Accent BEADLOCKS PRE-MOUNTED	2883162	2883171	2885047
5301 (HALO) Matte Black BEADLOCKS PRE-MOUNTED	2883161	2883170	2885048
5203 (HEXLR) Matte Black BEADLOCKS SOLD SEPARATELY	2883154	2883163	2885049
5204 (WYDE) Matte Black ○	2883155	2883164	2885051

○ LUG NUTS REQUIRED

## REPLACEMENT CAPS

### POLARIS

LUSTER	ALL WHEELS EXCEPT 5203 (HEXLR) & 5204 (WYDE)	1521508-410
MATTE BLACK		1521509-521
LUSTER	5203 (HEXLR)	1522243-410
MATTE BLACK		1522243-458
NEW HD MATTE BLACK	ALL WHEELS	5457498-458

### PRO ARMOR

LUSTER	ALL WHEELS EXCEPT 5203 (HEXLR) & 5204 (WYDE)	5453209-410
MATTE BLACK		5453209-458
MATTE BLACK	5204 (WYDE)	1523063-458
LUSTER	5203 (HEXLR)	1523015-410
MATTE BLACK		1523015-458

## 12mm x 1.5 SPLINED LUG NUTS

○ LUG NUTS REQUIRED

16 SPLINED LUG NUTS WITH WRENCH ADAPTER	2879332
4 SPLINED LUG NUTS WITHOUT WRENCH	2879331
12mm x 1.5 SPLINED LUG WRENCH	2204966

## COLBY VALVE SHORT ULTIMATE VALVE - 2 PACK

» 2883293

## COLBY COMBO VALVE KIT (16 PACK)

• Includes 8 ultimate valves and 8 emergency valves

» 2883294

## 2 WAYS TO PURCHASE

INDIVIDUAL WHEELS & TIRES - OR - COMPLETE SETS AS LISTED

Exclusively at Polaris Authorized Dealers

# WINCHES

TESTED **1,200+**  
PULLS AT MAX LOAD

OPERATES FULLY  
SUBMERGED

BUILT TO WITHSTAND  
**-29° C** TEMPERATURES

MILITARY  
TESTED & APPROVED



## FEATURES

**PRO** PRO HEAVY DUTY SERIES

**HD** HEAVY DUTY SERIES

ALL POLARIS ENGINEERED  
WINCHES COME WITH:

- ✓ FAST WIRE CONNECTION TO POLARIS PULSE SYSTEM
- ✓ HOOK WITH STRAP
- ✓ CUT STEEL GEARS & SEALED DRIVETRAIN
- ✓ SEALED PERMANENT MAGNET MOTOR



1. Set Dial to FREE SPOOL (N) to attach Winch Hook
2. Set Dial to PULL (L) for Winch Mode
3. Set Dial to ROPE RECOVERY (H) for 5x Faster Rope Recovery



NOT AVAILABLE

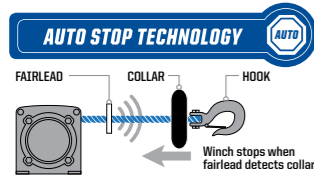

Stops winch at end of pull to prevent driveline stress and plow overlifting



WITH ALUMINUM FAIRLEAD

ADD AUTO STOP UPGRADE

2881288  
SYNTHETIC ROPE REQUIRED



WITH STEEL ROLLER FAIRLEAD

## PREMIUM SYNTHETIC ROPE

- Lightweight & Easy to Handle
- Superior Flexibility & Strength
- 15 m Long



ADD SYNTHETIC ROPE

2879187



## WIRELESS REMOTE

15 m range wireless remote control with unique code for interference-free operation



ADD WIRELESS REMOTE

2881287



## MODEL

2041 kg

2041 kg

POLARIS GENERAL XP 1000/4 '20-21

2883861

2883860

POLARIS GENERAL 1000/4 '19-21

# PLOW & TRACKS

## GLACIER PRO HD PLOW SYSTEM

» 183 cm or 168 cm Blades

GLACIER PRO HD GIVES YOU

» Choice of poly or steel

» Manual angle system standard



168 cm POLY BLADE  
BEST FOR CORROSION RESISTANCE



183 cm STEEL BLADE  
BEST FOR BIG JOBS YEAR AFTER YEAR

CREATE YOUR PLOW SYSTEM	STEP 1 SELECT A MOUNT	STEP 2 SELECT A FRAME	STEP 3 SELECT A LIFT METHOD	STEP 4 SELECT A BLADE	STEP 5 SELECT ACCESSORIES
MODELS	MOUNT	FRAME	WINCH	BLADES	ACCESSORIES
POLARIS GENERAL XP 1000/4 '20-21	2881763	2880260 <b>TOP SELLER</b>	Polaris PRO HD 2041 kg Winch 2883861 POLARIS GENERAL XP 1000/4 '20-21 POLARIS GENERAL 1000/4 '19-21	183 cm Steel 2880270 168 cm Poly 2880269 168 cm Steel 2880268	183 cm Blade Snow Deflector 2858541 183 cm HD Wear Bar 2879875 183 cm Wear Bar 2204976 168 cm Blade Snow Deflector 2879866 168 cm HD Wear Bar 2879868 168 cm Wear Bar 2879867 Plow Marker 2872726 168 cm Blade Plow Shoe 2208864 Shear Pin 2205527 Replacement T Shear Pin 2204829 Extension for Tracks 2880267 Heavy Duty Deflector 2884160
POLARIS GENERAL 1000/4 '16-21			Hydraulic Plow Angle 2885102 POLARIS GENERAL 1000/4 '16-18 Hydraulic Plow Controller 2883391 POLARIS GENERAL XP 1000/4 '20-21 POLARIS GENERAL 1000/4 '16-21		

## GLACIER HD PLOW SYSTEM

» 168 cm Blades

GLACIER HD GIVES YOU

» Choice of poly or steel

» Manual angle system standard



168 cm POLY BLADE  
BEST FOR CORROSION RESISTANCE



168 cm STEEL BLADE  
BEST FOR BIG JOBS YEAR AFTER YEAR

## DURABLE BLADES

Choose a steel blade for longevity and increased rigidity or a lightweight non-stick, poly blade that's easier on plowing surfaces.

CREATE YOUR PLOW SYSTEM	STEP 1 SELECT A MOUNT	STEP 2 SELECT A FRAME	STEP 3 SELECT A LIFT METHOD	STEP 4 SELECT A BLADE	STEP 5 SELECT ACCESSORIES
MODELS	MOUNT	FRAME	WINCHES	BLADES	ACCESSORIES
POLARIS GENERAL XP 1000/4 '20-21	2883256	2882927	Polaris HD 2041 kg Winch 2883860 POLARIS GENERAL XP 1000/4 '20-21 POLARIS GENERAL 1000/4 '19-21	168 cm Poly 2880269 168 cm Steel 2880268	168 cm Blade Snow Deflector 2879866 168 cm HD Wear Bar 2879868 168 cm Wear Bar 2879867 Plow Marker 2872726 168 cm Plow Shoe 2208864 Shear Pin 2205527 Replacement T Shear Pin 2204829
POLARIS GENERAL 1000/4 '16-21					



## PROSPECTOR PRO TRACK MOUNTS

• Install in place of tires and wheels. Tracks sold separately.

» 2880649  
POLARIS GENERAL 1000/4 '16-21

» 2885117  
POLARIS GENERAL XP 1000/4 '20-21

## PROSPECTOR PRO TRACK

» 2880758

POLARIS GENERAL 1000/4 '16-21  
POLARIS GENERAL XP 1000/4 '20-21  
If using Glacier Pro Plow System, Track Plow Extension is required (2880267)

ACCESSORIES

WINDSHIELDS & REAR PANELS

DOORS

ROOFS & PROTECTION

STORAGE CAB COMFORT & HUNT

COOLERS

RIDE COMMAND & AUDIO

LIGHTING

WHEELS & TIRES

WINCHES & PLOWS

# FOR THE LIFE OF YOUR RIDE

**POLARIS ENGINEERS PARTS THAT PUSH THE LIMITS WITHOUT SACRIFICING STRENGTH AND DURABILITY.** We build our products so anyone with the right tools can maintain their vehicle from their own garage - and get them back on the trails where they belong.

## MAINTENANCE TIP

### BREAK-IN PERIOD

The break-in period for your new GENERAL is the first 25 hours of operation, or the time it takes to use the first two tanks of fuel. No single action on your part is as important as a proper break-in period. Careful treatment of a new engine will result in more efficient performance and longer life for the engine.

NOTICE: Excessive heat build-up during the first three hours of operation will damage close-fitted engine parts. Do not operate at full throttle or high speeds for extended periods during the first three hours of use.

### AIR FILTERS

A clogged air filter can restrict air flow to the engine leading to reduced engine performance, engine life or catastrophic failure.

### BRAKE PADS

Maintaining and/or replacing brakes are critical to the safety and functionality of a vehicle. Brake pads should be checked for wear and oil or grease (petroleum products) contamination and brake discs should be checked for cracks, excessive corrosion or warping.

### HALF SHAFT

Check for tear and punctures in the boot which can lead to CV joint wear that can contribute to axle failure.

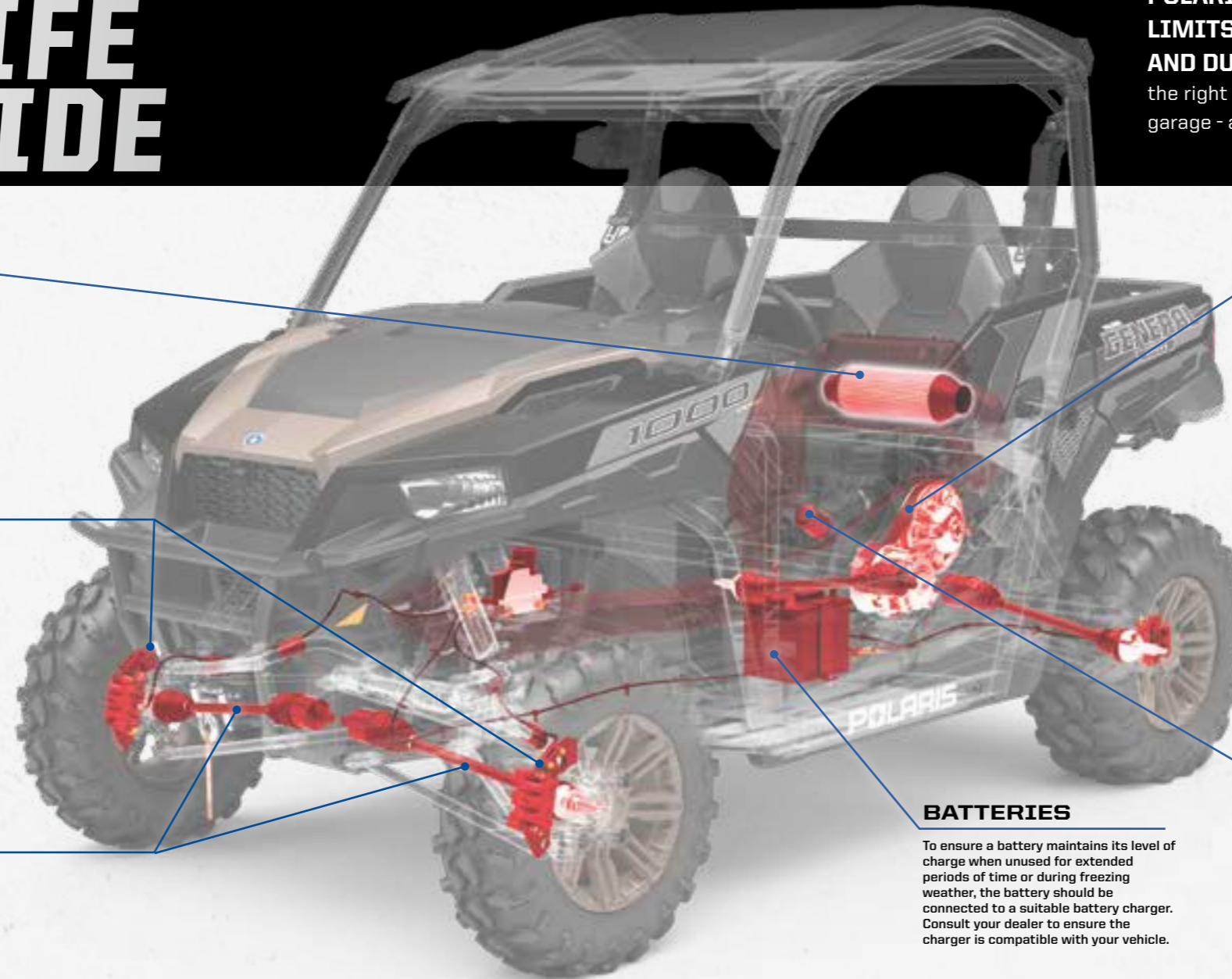

### DRIVE BELTS

Polaris Engineered belts deliver unmatched performance for your off-road vehicle. Developed and tested on all our engines for all environments and conditions. Check your belt for delamination, hour glassing and glazing.

#### BREAK-IN PERIOD

- Use lower gear (if available) while varying speeds and avoiding wide open throttle for 8-16 km
- If no low gear is available, vary at moderate speeds while avoiding wide open throttle for 80 km

#### OUR INVESTMENT

- 32,187 km of field testing
- Thousands of dyno hours
- 18+ months of development (3,000+ design hours) per belt
- 1200+ vehicle validation hours
- Collaboration with powertrain & clutch engineers

#### YOUR ADVANTAGE

- No clutch recalibration
- Less wear & tear due to heat
- Ensure maximum vehicle performance
- More time riding, less time wrenching
- Produced in collaboration with powertrain and clutch engineers to ensure a perfect fit, maximum performance and ultimate durability

### BATTERIES

To ensure a battery maintains its level of charge when unused for extended periods of time or during freezing weather, the battery should be connected to a suitable battery charger. Consult your dealer to ensure the charger is compatible with your vehicle.

### OIL FILTERS

Change oil filters with every oil change to provide the best engine protection and keep the engine operating at peak performance.

**FOLLOW RECOMMENDED SERVICE INTERVALS IN THE OWNER'S MANUAL**

## MAINTENANCE SCHEDULE

25 HRS / 400 km

### BREAK-IN MAINTENANCE

- ENGINE OIL:** CHANGE
- GENERAL LUBRICATION:** ALL FITTINGS, PIVOTS, CABLES, ETC.
- AIR FILTER:** INSPECT & REPLACE AS NEEDED
- EXHAUST SYSTEM:** INSPECT & CLEAN  
INSPECT FOR LEAKAGE OR CARBON BUILD UP AT JOINTS  
INSPECT & CLEAN SCREEN TYPE SPARK ARRESTOR

50 HRS / 800 km

### 6 MONTHS

- EXHAUST SYSTEM:** INSPECT & CLEAN  
INSPECT FOR LEAKAGE OR CARBON BUILD UP AT JOINTS  
INSPECT & CLEAN SCREEN TYPE SPARK ARRESTOR
- GENERAL LUBRICATION:** ALL FITTINGS, PIVOTS, CABLES, ETC.
- DRIVE BELT:** INSPECT & ADJUST  
REPLACE AS NEEDED

100 HRS / 1600 km

### 12 MONTHS

- ENGINE OIL:** CHANGE
- DRIVE BELT:** INSPECT & ADJUST  
REPLACE AS NEEDED
- TRANSMISSION FLUID:** CHANGE
- AIR FILTER:** INSPECT & REPLACE AS NEEDED
- EXHAUST SYSTEM:** INSPECT & CLEAN  
INSPECT FOR LEAKAGE OR CARBON BUILD UP AT JOINTS  
INSPECT & CLEAN SCREEN TYPE SPARK ARRESTOR

150 HRS / 2400 km

### 18 MONTHS

- ENGINE OIL:** CHANGE
- BATTERY:** TEST, CLEAN, & CHECK FLUID LEVEL  
REPLACE AS NEEDED
- DRIVE BELT:** INSPECT & ADJUST  
REPLACE AS NEEDED
- TIRES:** INSPECT CONDITION & PRESSURE
- EXHAUST SYSTEM:** INSPECT & CLEAN  
INSPECT FOR LEAKAGE OR CARBON BUILD UP AT JOINTS  
INSPECT & CLEAN SCREEN TYPE SPARK ARRESTOR

200 HRS / 3200 km

### 24 MONTHS

- ENGINE OIL:** CHANGE
- BRAKE PADS & FLUID:** INSPECT & CLEAN  
REPLACE BRAKE FLUID  
REPLACE AS NEEDED
- SPARK PLUGS:** INSPECT  
REPLACE AS NEEDED
- AIR FILTER:** INSPECT & REPLACE AS NEEDED
- EXHAUST SYSTEM:** INSPECT & CLEAN  
INSPECT FOR LEAKAGE OR CARBON BUILD UP AT JOINTS  
INSPECT & CLEAN SCREEN TYPE SPARK ARRESTOR

250 HRS / 4023 km

### 30 MONTHS

- ENGINE OIL:** CHANGE
- BATTERY:** TEST, CLEAN, & CHECK FLUID LEVEL  
REPLACE AS NEEDED
- DRIVE BELT:** INSPECT & ADJUST  
REPLACE AS NEEDED
- GENERAL LUBRICATION:** ALL FITTINGS, PIVOTS, CABLES, ETC.
- EXHAUST SYSTEM:** INSPECT & CLEAN  
INSPECT FOR LEAKAGE OR CARBON BUILD UP AT JOINTS  
INSPECT & CLEAN SCREEN TYPE SPARK ARRESTOR

300 HRS / 4828 km

### 36 MONTHS

- ENGINE OIL:** CHANGE
- AIR FILTER:** INSPECT & REPLACE AS NEEDED
- GEARCASE & TRANSMISSION:** REPLACE FLUIDS
- EXHAUST SYSTEM:** INSPECT & CLEAN  
INSPECT FOR LEAKAGE OR CARBON BUILD UP AT JOINTS  
INSPECT & CLEAN SCREEN TYPE SPARK ARRESTOR

CHECK YOUR OWNER'S MANUAL FOR ADDITIONAL RECOMMENDED SERVICE ITEMS AND VEHICLE-SPECIFIC TIMING



## SPECIFIC NEEDS, *SPECIFIC OILS*

Polaris invests millions in engine development, and part of that investment is making sure its lubricants—critical to engine performance—are the right formula for your specific engine. The amount of testing data and engineering resources used in developing Polaris lubricants would overwhelm an aftermarket company. Therefore, the aftermarket must spec an oil to an industry-wide standard that must account for a variety of operating parameters.

PS-4 is designed specifically for Polaris 4-cycle engines and has high film strength and wear protection under extreme loads and temperatures. Exclusive anti-wear additives protect engine parts with extra rust and corrosion protection.

### PS-4 FULL-SYNTHETIC OIL

• PS-4 is optimal for ambient operating temperatures of -40° C to 38° C

- 1L • 2877263
- 4L • 2877264
- 25L • 2877868
- 60L • 502338
- 200L • 2878003

### PS-4 EXTREME-DUTY FULL-SYNTHETIC OIL

• PS-4 Extreme Duty is optimal for ambient operating temperatures of -18° C to 53° C

- 1L • 2879037
- 4L • 2879251
- 25L • 2879252
- 60L • 2879003
- 200L • 2879038

### PS-4 OIL CHANGE KIT

• Contains the correct amount of oil for your vehicle and correct oil filter

- » 2202166  
SINGLE 570, TWIN 600, TWIN 700, TWIN 800
- » 2879323  
RANGER/RZR 900/1000
- » 2880913  
POLARIS ACE/ETX 325
- » 2877473  
330500, SPORTSMAN 550/850/1000

# POLARIS

ENGINEERED PARTS  
& LUBRICANTS

## FOR THE LIFE OF YOUR RIDE ONLY THE BEST WILL DO

To create the best oil for any terrain, we invest in rigorous testing to ensure our oil delivers the consistency and performance you demand. The results are Polaris Engineered Lubricants that are tested and perfected to deliver excellent total engine protection for the life of your ride.

### WHAT COUNTS IN OIL TESTING:

1. Does it protect the engine at high temperatures?
2. Does it keep the engine free from carbon and buildup?
3. Does the oil hold its viscosity over time?

### ENGINE CHECKPOINTS

When evaluating an engine oil and its ability to protect and preserve the engine's power output and lifespan, Polaris engineers focus on key areas within the engine, some of the most critical ones include:

**RING LANDS:** Poor oxidative performance can lead to carbon and varnish buildup, which results in poor ring seal and loss of power, combustion blow by and fuel dilution of the oil.

**PISTON RINGS:** During the combustion process, extreme pressures are placed on the top ring, forcing it outward toward the cylinder wall, sealing the combustion chamber. With so much force applied, poor oil film strength between the top ring and the cylinder wall can lead to cylinder wear and loss of power.

**ROD BEARINGS:** Engine bearings ride on an extremely thin hydrodynamic film of oil. Poor oil film strength or using an oil with a thinner viscosity, can lead to premature bearing wear or even engine failure. Using an oil with high film strength and a strong viscosity, like PS-4 full synthetic, will extend the service life of your engine.

**CAMSHAFT:** Direct Acting Overhead Camshafts are used on many Polaris Prostar Engines. In this application the camshaft pushes directly on the valve, creating very high contact pressures compared to other camshaft configurations. These forces are so great that inferior oil can break down and be forced out of the contact area leading to increased wear. PS-4 full synthetic additives are specifically designed to provide wear protection against this.

### OIL DEVELOPMENT

**12 DEDICATED  
TEAM MEMBERS**

**FOCUSED ON  
POLARIS OIL**

**18+  
MONTHS**

**DEVELOPMENT  
& TESTING**

**75,000+  
HOURS**

**DYNO  
TESTING**

**64,374  
KILOMETERS**

**FIELD  
TESTING**

## ENGINEERED TO MAXIMIZE THE LIFE OF YOUR RIDE

All Polaris fluids—from anti-freeze to brake fluid—are developed for your vehicle. Trust the only fluids perfectly engineered for your needs.

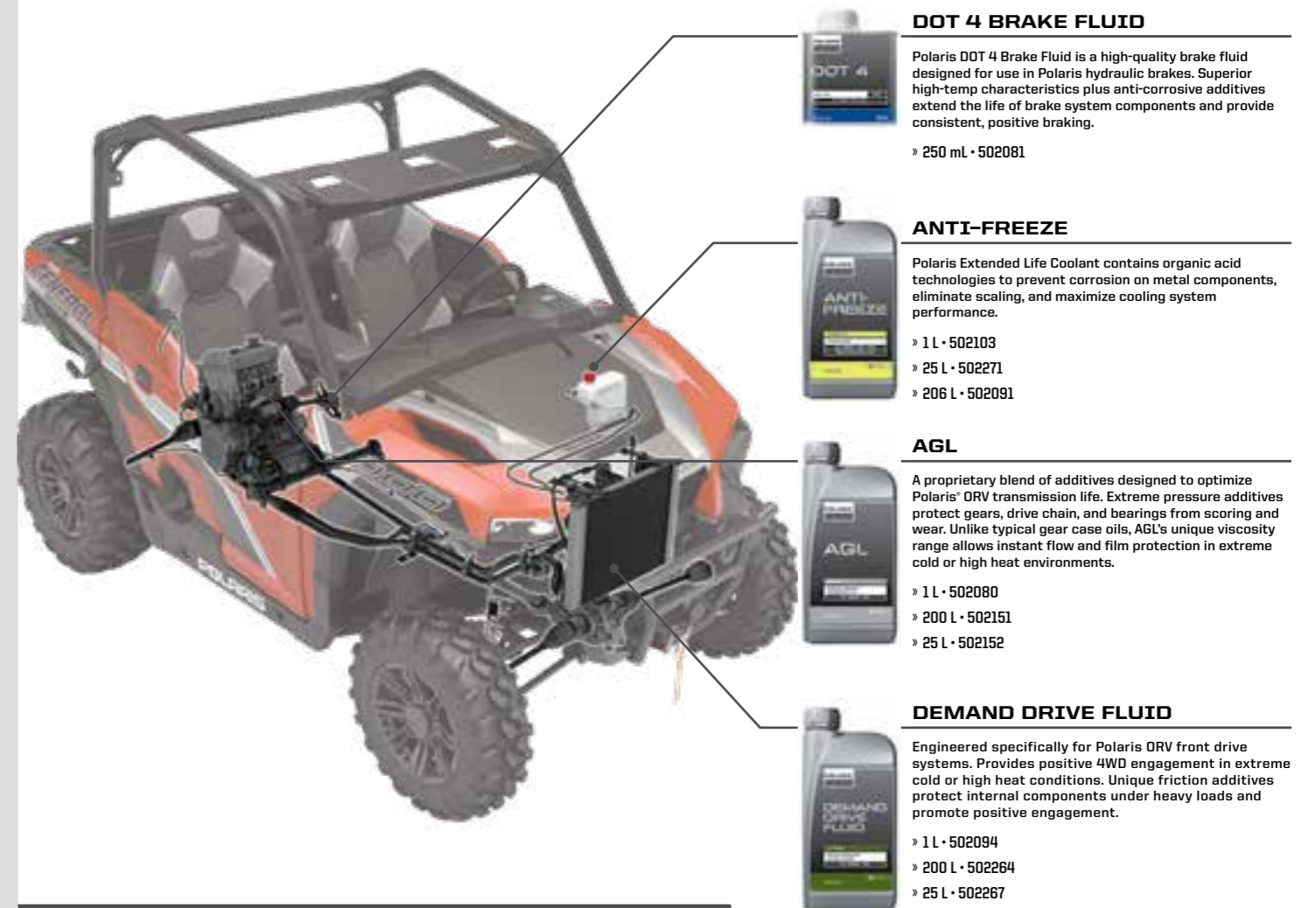

### DOT 4 BRAKE FLUID

Polaris DOT 4 Brake Fluid is a high-quality brake fluid designed for use in Polaris hydraulic brakes. Superior high-temp characteristics plus anti-corrosive additives extend the life of brake system components and provide consistent, positive braking.

- » 250 mL • 502081

### ANTI-FREEZE

Polaris Extended Life Coolant contains organic acid technologies to prevent corrosion on metal components, eliminate scaling, and maximize cooling system performance.

- » 1L • 502103
- » 25 L • 502271
- » 206 L • 502091

### AGL

A proprietary blend of additives designed to optimize Polaris' ORV transmission life. Extreme pressure additives protect gears, drive chain, and bearings from scoring and wear. Unlike typical gear case oils, AGL's unique viscosity range allows instant flow and film protection in extreme cold or high heat environments.

- » 1L • 502080
- » 200 L • 502151
- » 25 L • 502152

### DEMAND DRIVE FLUID

Engineered specifically for Polaris ORV front drive systems. Provides positive 4WD engagement in extreme cold or high heat conditions. Unique friction additives protect internal components under heavy loads and promote positive engagement.

- » 1L • 502094
- » 200 L • 502264
- » 25 L • 502267

Proper lubricant application and timing will ensure optimal vehicle performance. Please refer to your owner's manual for lubricant change interval schedules.



### CARBON CLEAN

Polaris Carbon Clean prevents ethanol corrosion, stabilizes fuel, and cleans fuel injectors, piston ring lands, intake systems, and combustion chambers. Helps maintain peak HP and improves fuel economy.

- » 125 mL • 502082



### FUEL STABILIZER

Fuel Stabilizer prevents ethanol corrosion and stabilizes fuel for up to 2 years. Dual-antioxidant formula protects against gum and varnish for easy starting.

- » 125 mL • 502100



### ANGLE DRIVE FLUID

SPORTSMAN, RANGER, RZR ANGLE DRIVE GEAR CASE SYSTEMS

- » 1L • 502089
- » 25 L • 502268
- » 202 L • 502266



### PREMIUM GAS SHOCK OIL

- » 1L • 502098



### ALL-SEASON GREASE TUBE

- » 400 g • 502068

# SERVICE PARTS

Polaris Engineered service parts deliver unmatched performance and fit for your off-road vehicle.

All service parts are engineered specifically for your machine. Which means everything is designed, tested and perfected to maximize the life of your ride. Getting Polaris Engineered parts is a decision that pays off in the long run, because it ensures there is a long run.

 **PARTS FINDER** VISIT YOUR POLARIS DEALER TO SHOP FOR SERVICE PARTS.

OVER  
**100,000**  
PARTS  
AVAILABLE!



## FOR THE LIFE OF YOUR RIDE

Maintenance is the key to keeping your Polaris off-road vehicle performing at its peak. Items like belts, lubricants, and batteries represent only a few of these critical items engineered specifically by Polaris.



## POLARIS ENGINEERED DRIVE BELTS

### TESTED, PERFECTED

*We test each belt on the intended vehicle - we don't just try to make an existing belt "just work".*

- Amery Kuhl, Polaris CVT System Engineer

#### OUR INVESTMENT

- 32,187 km of field testing
- Thousands of dyno hours
- 18+ months of development (3,000+ design hours) per belt
- 1200+ vehicle validation hours
- Collaboration with powertrain & clutch engineers

#### YOUR ADVANTAGE

- No clutch recalibration
- Less wear & tear due to heat
- Ensure maximum performance of your vehicle
- More time out riding, less time wrenching

**OUR INVESTMENTS ENSURE POLARIS BELTS  
OUTPERFORM YOUR EXPECTATIONS.**

# HD HEAVY DUTY PARTS



All Polaris parts are developed and tested to help you get the most out of your ride. Now, we're taking the passion of our riders, workers, and outdoor enthusiasts to the next level with HD Parts.

Engineered & designed for:

- Greater durability
- Enhanced performance
- Greater wear & tear capabilities
- All weather conditions

## NEW WHEELS & TIRES

Class leading durability for off-road performance and traction for confident driving in extreme conditions.

- » 1524022-458 • HD WHEEL - 14x7 (SHOWN)
- » 5417507 • PRO ARMOR HD-K - 29x10R14 (SHOWN)
- » 5457498-458 • HD WHEEL CENTER CAP (SHOWN)
- » 5415756 • PRO ARMOR XD-K FRONT
- » 5415757 • PRO ARMOR XD-K REAR

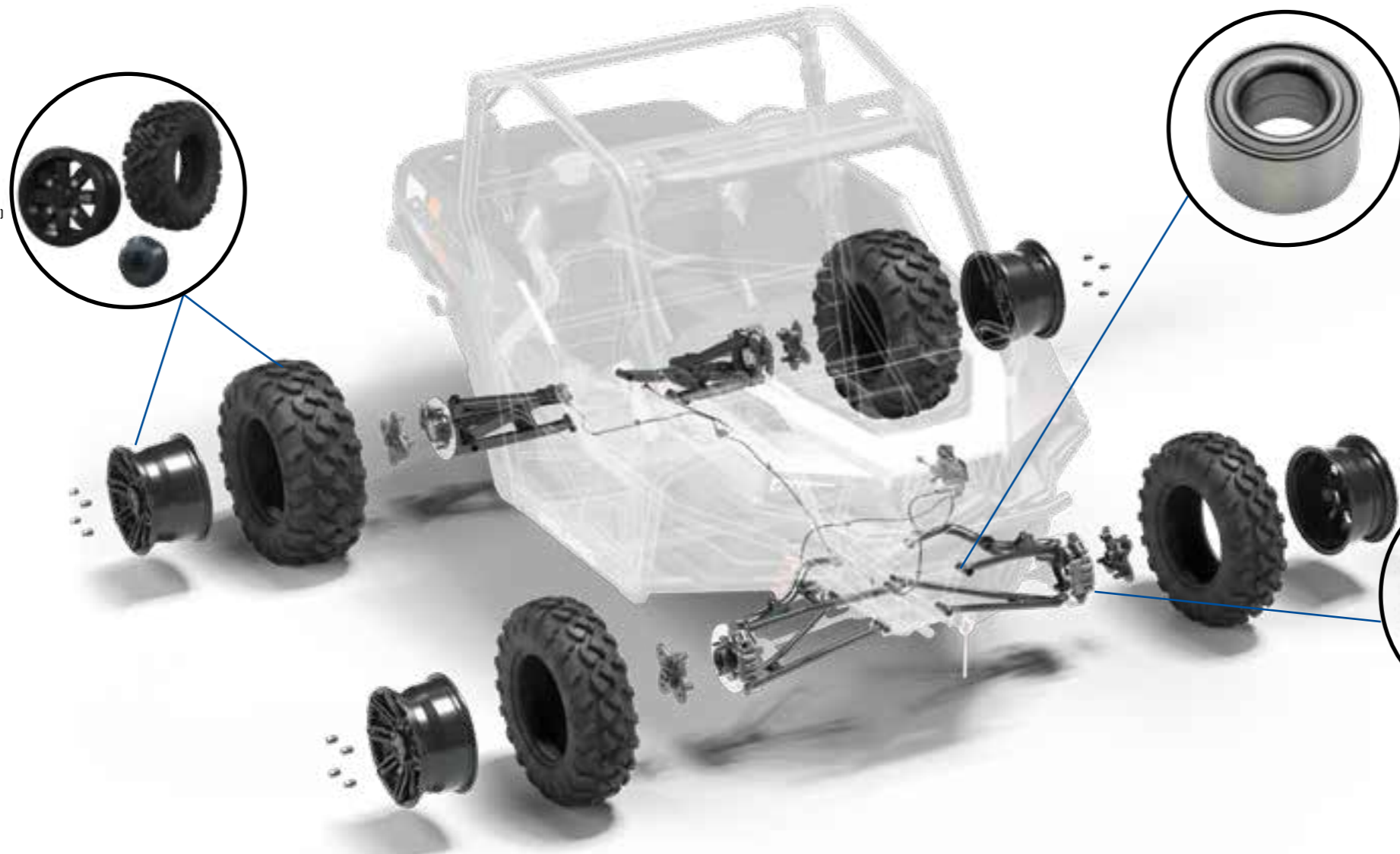

## NEW WHEEL BEARINGS

Fully sealed for added protection against intrusions. Made of a higher grade steel for extended life in extreme conditions.

LOCATION	OE	HD HEAVY DUTY PARTS
FRONT WHEEL BEARING	3514924	3515090
REAR WHEEL BEARING		

## COMING SOON BRAKES

Engineered to provide longer life and better stopping power while riding in extreme conditions.

\*Claims made based off testing and performance of Polaris HD Parts against standard OEM parts made by Polaris and competitor brands under normal use.

For more information regarding Polaris HD parts including vehicle compatibility, installation, and maintenance, please contact your authorized Polaris ORV dealer.

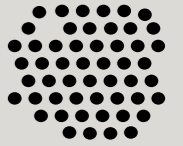

SAND



MUD



WATER



EXTREME COLD



EXTREME HEAT UP TO 54° C



HEAVY PAYLOADS

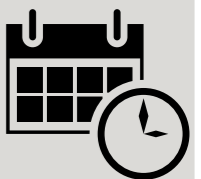

EXTENDED LIFE

# CV BOOT REPAIR KIT

FIX ON THE GO | TEMPORARY COVERAGE

- A quick trail side fix to increase trail time
- The flexible and durable boot material expands over a cone tool for CV boot repairs, without disassembling CV axles
- Universal fit - works as a temporary fix for most powersports axles
- All components fit inside the cone, and a cover is provided for compact durable storage
- Easily fits in a cargo box, attached to the roll cage, in the glovebox, or many other storage locations



Items shown are contained inside cone

## UTV CV BOOT REPAIR KIT

Kit includes the following items:

- (1) Expandable XL CV Boot
- (1) Reusable Cone Tool
- (2) CV Boot Clamps
- (1) Tube of Silicone Lube
- (1) Grease Packet
- (1) Cone Cover

## UTV TRAIL BOOT ONLY

» 2830527

## ATV

- CV REPAIR KIT 2830528
- TRAIL BOOT ONLY 2830529

### HOW TO INSTALL

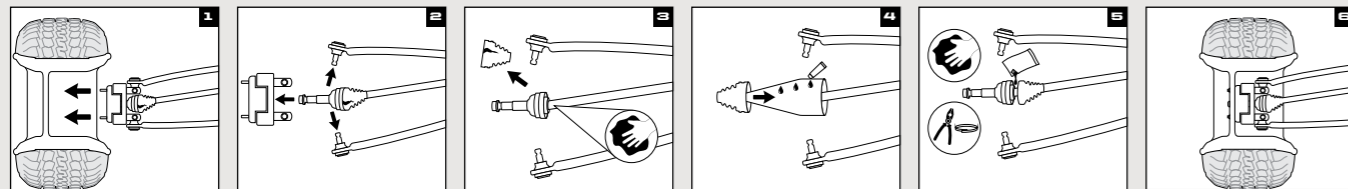

1. Remove wheel and axle nut.

2. Remove brake caliper, hub, tie rod, & upper & lower ball joints.

3. Remove old boot & clean joint.

4. Spread silicone lube on entire cone tool. Slide boot over cone tool, large end first. See package for outer boot instructions.

5. Empty the bag of grease into the CV joint/boot, clean sealing points & install clamps.

6. Reassemble tie rod, ball joints, brake caliper, axle nut, tire & wheel.

Refer to your service manual for further instructions and torque specifications.  
\*Designed for temporary CV boot repair. Purchase the OEM CV Boot for a permanent repair.

# KEEP IT CLEAN

## CLEAN

### ALL-PURPOSE CLEANER

- Professional cleaner, which is formulated with a low pH-value. The product spreads well on surfaces and adheres on them for effective cleaning action. Perfectly compatible with rubber, plastic and painted surfaces. The formulation is biodegradable.

» 500 mL • 502309

## SHINE

### INSTANT SHINE & DETAILER

- The INSTANT SHINE AND DETAILER is developed for cleaning action without water. Removes insects, dust and dirt with almost no effort. Applicable for plastics, visors, windscreens, paint and metal. The wipe and shine formulation makes surfaces shine, works water repellent and also has an antistatic effect. Perfect for customers living in urban areas with no access to water, for bike trips or showroom bikes.

» 500 mL • 502303



## TRAILERING



### CALIBER RAMP PRO

- Designed for ATVs and UTVs up to 127 cm wide
  - Integrated grip glides for ultimate traction
  - Folding sides for easy transportation & storing
- » 132 cm x 229 cm • 2884576



### ALUMINUM ARCHED LOADING RAMPS

- » 193 cm x 30.5 cm • 907 kg • 2875384
- » 224 cm x 30.5 cm • 1361 kg • 2875386



### LIGHTWEIGHT TRI-FOLD RAMPS

- Ramp folds up for transport
  - Capacity for up to 680.7 kg
  - Safety straps included
- » 183 cm x 130 cm • 2875385
- » 208 cm x 130 cm • 2875860



### FOLDING ALUMINUM ARCHED RAMPS

- Ramp folds up for transport
  - Capacity up to 1361 kg
  - Safety straps included
- » 224 cm x 30.5 cm • 2875387

## HITCHES

### 3:1 HITCHES

VERSATILE 3 IN 1 FUNCTIONALITY

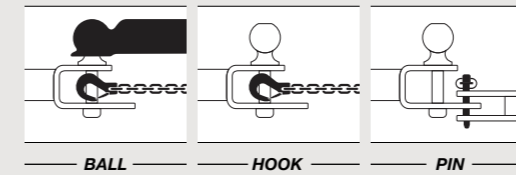

- Ball, pin and hook design
- Durable, rust resistant steel with black powdercoated finish
- Removable ball
- HD 1.6 cm pin and clip



### HITCH WITH 5 cm BALL

- » 5 cm x 5 cm RECEIVER 2830522
- » 3 cm x 3 cm RECEIVER 2830523



### 4.8 cm BALL

- 4.8 cm replacement ball for hitch
  - Designed to work with 3:1 Hitch
- » 2830524



### RECEIVER HITCH

- » 5 cm RECEIVER TONGUE 2875320
- » FRONT HITCH RECEIVER 2878846



### TRAILER BALL 1.9 cm SHANK

- » 4.8 cm BALL • 2877602
- » 5 cm BALL • 2877603

## STRAPS & ROPES



### RECOVERY STRAP

- 5 cm x 9.1 m (8165 kg)
  - Comes with carry bag
- » 2884033



### RATCHET STRAP

- 3.8 cm x 4.6 m straps, 2 Pack
  - Heavy duty webbing
  - 2495 kg maximum load, 831 kg working load
- » 2884031



### RATCHET STRAP

- 5 cm x 6.1 m Ratchet Straps
  - Heavy duty webbing, floating D-rings, double J-hooks
  - 4536 kg maximum load, 1497 kg working load
- » 2884032



### SHOCK STRAPS

- 3.8 cm 1361 kg breaking strength
  - Keeps tension on tie-down straps to secure load, 2 Pack
- » 3.8 cm x 4.6 m • 2883296
- » 3.8 cm x 2.1 m • 2883295

## COVERS



### TRAILERABLE COVER BY POLARIS

- » 2-SEAT • 2881841
- POLARIS GENERAL XP 1000 '20-21
- POLARIS GENERAL 1000 '16-21
- » 4-SEAT • 2881787
- POLARIS GENERAL XP 4 1000 '20-21
- POLARIS GENERAL 4 1000 '17-21



### POLARIS SxS CAMO FIELD COVER

- » 2882160
- POLARIS GENERAL XP 1000/4 '20-21
- POLARIS GENERAL 1000/4 '16-21



# ELEVATE YOUR ADVENTURE



## 0% FINANCE



### INTEREST-FREE FINANCE\*

Included on all new Sportsman, Ranger, RZR, General and Scrambler models†.

## ATVTRAC



**QUICK AND SIMPLE OFF-ROAD SECURITY**  
ATVTrac is included with all our vehicles\*\*, alongside a free 12 months subscription. Simply complete the online registration process and you'll be protected within minutes.

## TWO YEAR WARRANTY



### ULTIMATE PEACE OF MIND

All models come with a 2-year warranty as standard.



**GET FREE EASI TRAINING WORTH £180\***  
The European All-Terrain Vehicle Safety Institute provides free training courses for operators when they purchase a new POLARIS® ATV or SxS.

VISIT  
**POLARISBRITAIN.COM** FOR MORE INFO

**POLARIS**

MY21 GENERAL APP ACC EMEA

\* Subject to terms and conditions. † Excludes Youth.